



TROEMNER





Table of Contents

3	About Troemner	69	Electronic Balance Weights	107	Stainless Steel Slotted Weights
11	Selecting Weights and Certificates	79	Stainless Steel Heavy Capacity Weights	111	Stainless Steel Hook Weights
27	Analytical Precision Weights	83	Stainless Steel Test Weights	117	Economical Stainless Steel Weights
45	OIML Precision Weights	99	Cast Iron Heavy Capacity & Grip Handle Weights	125	Custom Weights and Cases
61	Cal-Paks™	103	Cast Iron Slotted Weights	127	Custom Weight Carts
				129	Weight Accessories



The Troemner Advantage

Troemner is the world's leading supplier of precision weights and mass standards. Since 1838, Troemner has enhanced its reputation as being the premier precision weight company by having industry recognized metrologists and highly trained calibrators on staff. Troemner's production of precision weights involves using the finest materials and equipment available in a state-of-the-art facility. For these important reasons, Troemner is capable of providing unmatched measurements and metrological analysis to provide our customers with the precision weights they need.

Our advantages are:

People with Experience

We have been manufacturing weights and conducting mass measurements for over 170 years! We have four full-time industry recognized metrologists on staff who track and control our measurement processes to assure superior quality. Being the largest private mass laboratory in the world, no one makes more mass measurements per day than Troemner. Like anything else, with repetition comes learning, refinement and constant improvement.

World Class Laboratories

Our mass laboratories were specifically constructed to create an environment of stable temperature and humidity, low vibrations, and low air velocity, which is suitable for making precise mass measurements. Troemner's Class I Laboratory is the largest private mass metrology laboratory in the world.

State-of-the-Art Equipment

Troemner has the largest collection of mass comparators in the world, and we are constantly purchasing new comparators to keep our capabilities up-to-date to maintain the highest level of precision. Additionally, seven newly acquired robots allow Troemner to provide impeccable service by increasing not only precision, but also efficiency. We also use proprietary software to track the performance of our equipment and standards to assure that our calibration system is in control. Magnetic permeability testing and magnetic susceptibility testing are incorporated into our processes and utilize a susceptometer.

Material

We select only the finest raw materials in order to manufacture high quality weights. Troemner is the only supplier that has a special stainless steel blend called Troemner Alloy 8, which possesses closely controlled density (8.03 g/cm^3), extremely low magnetic properties, good stability and resistance to corrosion.

Surface Finish and Appearance

We start with the best material so we can achieve excellent surface finishes on the final product.

Low Reported Uncertainty

The true test of how well we perform calibrations is in the reported uncertainty which provides a higher confidence to the user in the repeatability of our calibration process.



TROEMNER

ofare, NJ • 08086-0087 • USA
1-866-1601 • www.troemner.com

57074

TROEMNER
www.troemner.com



Our History

The Beginning

Troemner started as a manufacturer of scales, balances and weights in Philadelphia, Pennsylvania. Henry Troemner, a German immigrant, was originally a locksmith and learned the balance craft after he arrived in Philadelphia.

From the beginning, Troemner earned a reputation as being a manufacturer of high quality products. The business grew steadily after the discovery of gold in California on January 24, 1848, as the company was known for its bullion and assay balances. Henry Troemner's three sons continued to develop and grow the business, and by the early 1900's Troemner was recognized internationally as a world leader in the balance and scale manufacturing industry.

During the 1950's Troemner's balance and scale product line was updated to meet market demand and the production of precision weights became a larger part of its overall business. In 1958, Troemner published the company's first comprehensive catalog of standard weights and began to offer a weight calibration service for customers' weights. This important service is one that continues to this day.

Over the years Troemner has enhanced its reputation as being the premier company in the metrology industry by achieving ISO 9001 certification and accreditation in our laboratories by the National Institute of Standards and Technology (NIST) administered National Voluntary Laboratory Accreditation Program (NVLAP+).

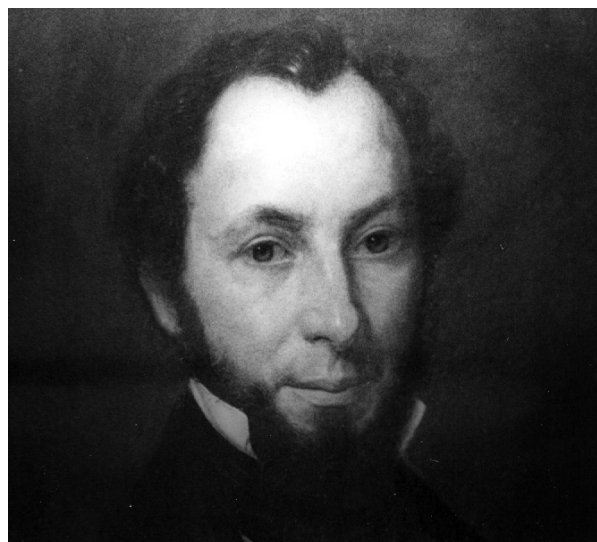

Henry Troemner

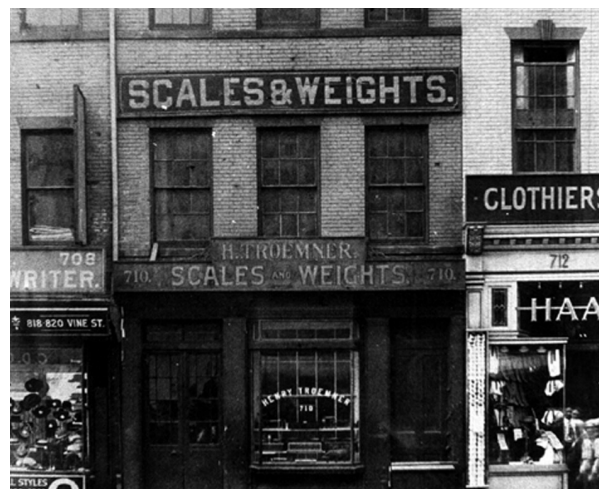

Factory and Office
710 Market Street, Philadelphia, PA

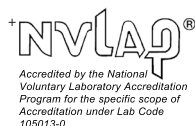

Troemner Today

Over the years Troemner has continued to expand and increase its expertise in manufacturing and measurement capabilities. Troemner relocated to Thorofare, New Jersey on May 1, 1999 to a state-of-the-art specially designed corporate headquarters. The headquarters were planned by a team of employees, engineers, and architects to specifically meet the customers' needs for high precision calibrations.

Troemner's laboratories provide customers with all the data and traceability information they need for their calibration items. The Calibration Laboratories' physical environment and state-of-the-art equipment enable Troemner to produce measurements with very small uncertainties for its customers.

Troemner is not only committed to quality calibrations, but to the product itself as evidenced by the introduction of a unique material used to manufacture weights called Troemner Alloy 8. Troemner Alloy 8 possesses closely controlled density (8.03 g/cm^3), extremely low magnetic properties, good stability, and resistance to corrosion. Troemner is committed to achieving the highest levels of accreditation for all of our calibration services which include mass, mass magnetic susceptibility, mass density determination, pipettes, temperature, humidity, pressure, thermal mass flow, electrical, dimensional, time, and frequency. We continue to research and add new calibration services to meet the diverse needs of our customers.



Troemner's Corporate Headquarters - May 2012
Thorofare, NJ, USA



Our Calibration System

Calibration & Traceability Philosophy

Troemner is the world's largest independent mass calibration company. Our philosophy is to provide the highest level of calibration quality by pursuing every measurement detail in order to achieve the most accurate and repeatable calibrations in the industry. We produce a precise measurement starting with a stable and tightly controlled environment, followed by using the finest equipment available, with highly trained personnel executing proven procedures. Our goal is to provide our customers with the lowest measurement uncertainties achievable.

World Class Calibration Facilities

The backbone of our calibration capabilities is the design, construction, and operation of our physical facilities. Troemner's Mass Calibration Laboratories were constructed to meet the strict environmental guidelines listed in NIST/NVLAP Handbook 150-2. Please visit our website at www.troemner.com for more information on these requirements.

In order to maintain the strictly controlled environment, the Mass Calibration Laboratories were designed and constructed as a building within a building. Within Troemner's corporate headquarters, three Echelon I Laboratories and one Echelon II Laboratory sit upon separate 30" foundations that are isolated from the rest of the building with layers of sand and concrete to eliminate vibration. The walls are 12" thick and provide a temperature and vapor barrier to the outside. The climate in each of the Mass Calibration Laboratories is strictly monitored and controlled with each laboratory having its own HVAC system. Temperature in the laboratory is measured to 0.05°C and maintained at $21.5 \pm 1^\circ\text{C}$, with no more than a



Calibration Laboratory

0.5°C change per hour. Humidity is measured to $\pm 2\%$ and maintained within 40-50%, with no more than a 5% change per hour. Barometric pressure is measured to 0.01 mm Hg. Although the temperature and humidity are tightly measured and controlled, the design of the air handling system allows for minimal air velocity so air currents are kept to a minimum.

Cutting Edge Equipment

All mass comparators used in Troemner's Mass Calibration Laboratories are state-of-the-art with the highest precision possible. Troemner can measure as precisely as 0.0001 mg. Each comparator rests on a marble table to reduce effects from vibration and has its own temperature probe mounted within the weighing chamber to measure the temperature at the time of calibration. The comparators are interfaced to a host computer outside the laboratory for processing calibration

data. Troemner's custom software programs ensure the accuracy of the data collection and calculation process. Troemner's staff of metrologists and calibrators are equipped with mass standards directly traceable to NIST and NPL (National Physical Laboratory).

Troemner's precision weights are sampled regularly throughout the manufacturing process to determine the magnetic properties of the material. Stainless steel is tested for magnetic permeability and for magnetic susceptibility. Once Troemner's two-piece weights are machined and polished, they are checked



Robotic Comparator

using a Gaussmeter prior to the calibration. Troemner's stainless steel one-piece weights are all individually tested for magnetic susceptibility using a state-of-the-art susceptometer. Troemner's susceptometer procedure is based on Dr. Richard Davis's paper, "Determining the Magnetic Properties of 1 kg Mass Standards". Working in collaboration with Dr. Davis and Dr. Nava-Martinez (CENAM), Troemner metrologist, Joe Moran, has completed an inter-laboratory comparison with several internationally recognized metrology organizations to determine the effectiveness of the susceptometer which is summarized in the technical paper, "Intercomparison Between CENAM, BIPM, and Troemner to Determine the Volume Magnetic Susceptibility of a 100 g Weight". Both papers on magnetic susceptibility are available at www.troemner.com.

Unmatched Standards

Troemner's traceability to nationally recognized standards is guaranteed. Direct traceability to NIST and NPL is achieved and maintained through the use of several standards that are not only returned to NIST and NPL on a regular schedule, but also are intercompared in our laboratories to monitor their stability.



Weight Standards

Highly Trained Personnel & Proven Calibration Procedures

World-class metrology facilities and state-of-the-art calibration equipment are only as good as the people who manage the measurement process. Troemner has an excellent staff of certified metrologists and NIST trained calibrators who adhere to strictly established metrology practices in order to provide low statistical uncertainties, second only to NIST. Our weighing instruments and mass standards are continually maintained according to the NIST Mass Measurement Assurance Program (MMA) procedures and to ISO/IEC 9001 and ISO/IEC 17025 guidelines. Troemner's procedures utilize multiple standards during a calibration to assure the accuracy of the process and to validate the standards. If a measurement does not pass statistical tests calculated during each calibration, then the measurements are repeated and an investigation is initiated to find the root cause of the failure.

Accreditation

Troemner's focus is to achieve the highest level of accreditations for weights, mass standards, and calibration services. Third party accreditations by internationally recognized organizations provide critical, regularly scheduled and unbiased assessments of Troemner's quality programs and technical capabilities. Accreditations assure our customers that Troemner meets and maintains the most rigorous testing and manufacturing standards.



Mass Comparator

Since 1995, Troemner's Mass Calibration Laboratories have been accredited by NVLAP+. Troemner offers NVLAP+ Accredited Mass Calibration Certificates for precision weights. Troemner can also provide you with NVLAP+ Accredited Magnetic Susceptibility Determination Calibration and NVLAP+ Accredited Density Determination Calibration for your one-piece precision weights.

The combination of a highly trained staff, controlled physical conditions, and precise equipment enables Troemner's Mass Calibration Laboratories to produce mass measurements with very small uncertainties. For more information on Troemner's Mass Calibration Laboratories, including photos, please visit www.troemner.com.

Additional Calibration Services Available

Troemner's detailed approach to mass calibration has led us to take our measurement control philosophy into other areas.

In order to fulfill our customers' needs we offer the following calibration services:

- NVLAP+ Accredited Pipette Calibration
- NVLAP+ Accredited Temperature Calibration
- NVLAP+ Accredited Humidity Calibration
- NVLAP+ Accredited Pressure Calibration
- NVLAP+ Accredited Thermal Mass Flow Calibration
- NVLAP+ Accredited Electrical Calibration
- NVLAP+ Accredited Dimensional Calibration
- NVLAP+ Accredited Time and Frequency Calibrations

Refer to www.troemner.com for the complete NVLAP+ Scope of Accreditation.

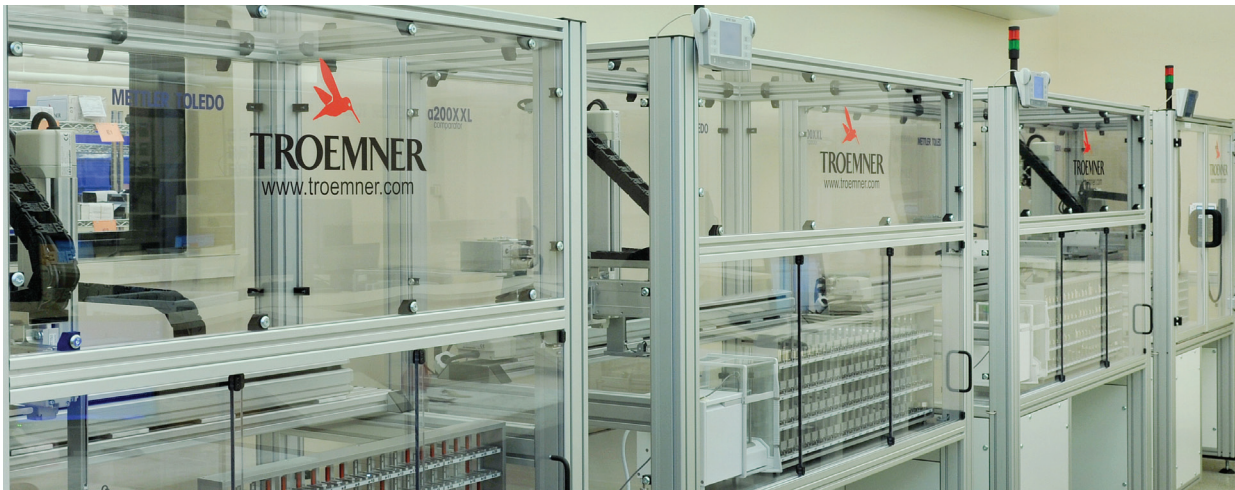

Robotic Comparators (Robot Row)



Selecting Weights and Certificates



Weight Selection

There are several shapes, designs and sizes available to meet your needs.

Selecting the proper weight for your application can be confusing given the number of weight classes, designs, and materials available. The following information can help in your weight selection process. A Troemner Sales Representative can also assist you in selecting the correct weight for your application. Please contact a Troemner Sales Representative at [800-249-5554](tel:800-249-5554) or visit our website at www.troemner.com to help you choose the proper weight for your application.

The following issues need to be considered when selecting weights:

1. Application Accuracy

The correct weight for an application should be more accurate than the precision of the weighing device, and must be more accurate than the required precision of your measurement result. It is recommended that a weight have an accuracy that is 1/3 of the measurement device readability and/or your measurement accuracy requirement.

2. Environment

Temperature and humidity can impact the stability of weights. We recommend stainless steel weights for applications in environments that have excess moisture, changes in

temperature or humidity, or are in corrosive environments. Stainless steel is much less prone to physical change as compared to cast iron or brass.

Cleanliness of the environment can impact how stable your weights will be over time. Environments with excessive airborne matter, such as dust, can impact the stability of weights. The smoother the surface of a weight, the easier it is to see foreign matter so it can be removed.

3. Reported Uncertainty on Calibration

The uncertainty reported on a calibration is just as important as the measured value itself. The uncertainty provides the statistical confidence that a laboratory has on its calibration process. The larger the uncertainty, the less confidence in the measured value. It is also important to realize that a measured value added to its associated uncertainty must be less than the tolerance for the weight to be considered within class tolerance.



Mass Calibration



Weight Certificates

4. Certification

Troemner offers a variety of calibration certificates to meet your specific needs. Certificates are described in detail in the "Certificate Options" section beginning on page 23.

5. Special Design or Construction

Troemner manufactures a variety of special application weights, such as weights with hooks or weights that can be stacked on a hanger in order to build up the total weight. Keep in mind that if you do not see what you need, please contact a Troemner Sales Representative at 800-249-5554 or troemner@troemner.com to discuss your special weight requirements.



Weight Specifications

General Information

Troemner offers the most comprehensive selection of precision weights and mass standards. Our weight selection includes every imaginable size, class, and type from 10,000 kg stainless steel weights to the extremely precise, highly polished one and two-piece stainless steel weights.

At Troemner, careful attention is paid to every detail of production. Weight bottoms are slightly recessed to expose the smallest possible area to wear. Weight heads and necks are precisely shaped to give a solid, sure grip to forceps or weight lifters. Troemner uses the finest materials available for the production of all of our weights and mass standards. For your most demanding applications, our precision weights are manufactured from Troemner Alloy 8, which is a specially developed stainless steel. Troemner Alloy 8 possesses closely controlled density (8.03 g/cm³), extremely low magnetic properties, good stability, and resistance to corrosion. We manufacture and calibrate weights to meet or exceed the highest tolerance standards of ANSI/ASTM, OIML, and NIST.

ANSI/ASTM E617

Standard Specification for Laboratory Weights and Precision Mass Standards

This specification covers various classes of weights and mass standards used in laboratories ranging from Class 000 to Class 7. Tolerances and design restrictions for each class are described in order that both individual weights and weight sets can be chosen for the appropriate applications. This specification also recognizes OIML R 111 that describes class E1, E2, F1, F2, M1, M2 and M3.

OIML R 111

Weights of Class E1, E2, F1, F2, M1, M2, M3

This international document describes the physical characteristics and metrological requirements of weights that are used for the verification of weights of a lower class of accuracy and with weighing instruments. This document includes a recommendation for seven classes of weights in tiers of uncertainty.

NIST Handbook 105-1

Specifications and Tolerances for Field Standard Weights

These specifications and tolerances are specific for reference and field standard weights (NIST Class F). Reference and field standard weights are used to test weighing devices where the weight of the item is required to determine the item's price. This document sets minimum requirements for standards used primarily to test commercial or legal for trade weighing devices for compliance with NIST Handbook 44. These devices include, but are not limited to, delicatessen scales, jewelry scales, postal and parcel post scales, and dairy product scales. This specification permits the use of a weight at its nominal value in normal testing operation, where the tolerance of the item under test is at least three times as great as the tolerance of the weight. This handbook also specifies the design, marking, adjusting cavities, and density of these weights. Any variation in design from Handbook 105-1 must be submitted to NIST for approval.

For more information visit www.troemner.com.





Selecting Weight Classes



Weight Applications by Class

In order to select the appropriate weight for your laboratory, you must first determine exactly how you intend to use the weight. Your unique application will help determine exactly which Troemner weight will suit your needs. Troemner's Tolerance Chart can be viewed on pages 19-20 or at www.troemner.com to assist you in selecting the appropriate weights.

The following guidelines explain the applications of the different classes of weights:

Troemner UltraClass Series

Available exclusively from Troemner, these weights are developed to meet the most demanding calibration needs with the ability to be adjusted. Consistent automated measurement means that Troemner UltraClass weights are the most precise two-piece weights available with weight tolerances that equal or exceed comparable ANSI/ASTM E617 and OIML R 111 class tolerances. Troemner UltraClass weights, 1 g through 20 kg, are made from our exclusive stainless steel, Troemner Alloy 8 (excluding Electronic Balance).

We guarantee for the life of all Troemner Alloy 8 Stainless Steel Precision Weights that they will maintain extremely low magnetic susceptibility. Troemner UltraClass weights combine high precision with the advantage of two-piece construction (1 g and larger) avoiding costly replacement issues associated with one-piece weights. UltraClass Platinum and UltraClass Gold come with free laser serialization and a corresponding NVLAP+ Accredited Certificate.



Two-piece construction means the weight is made of multiple pieces of stainless steel. The body of the weight is the primary piece and the knob of the weight is the secondary piece. The knob has a thread that screws into the body and is tightened. There is a cavity below the knob thread within the body which contains adjusting material, typically the same material from which the weight is made.

Troemner UltraClass weights and weight sets are available in a full range of weight denominations. UltraClass Platinum, UltraClass Gold, and UltraClass are available for Troemner Analytical Precision Weights, OIML Precision Weights and Electronic Balance Weights. Troemner UltraClass weights are two-piece alternatives to the one-piece weights with uncertainties slightly larger than the one-piece weights.

Troemner UltraClass Platinum - The weight tolerance is equal to ANSI/ASTM E617 Class 000 and Class E0*. This class is used as a primary standard for calibrating other reference standards and weights where the stability of the environment and careful handling are assured. This class is appropriate for calibrating high-precision analytical balances with a readability as low as 0.0001 mg.

Troemner UltraClass Gold - The weight tolerance is equal to ANSI/ASTM E617 Class 00 and meets or exceeds OIML R 111 Class E1. This class is used as a reference standard for calibrating other reference standards and weights where the stability of the environment and careful handling are assured. This class is appropriate for calibrating high-precision analytical balances with a readability as low as 0.001 mg.

Troemner UltraClass - The weight tolerance is equal to ANSI/ASTM E617 Class 0 and exceeds OIML R 111 Class E2. This class is used as a reference standard for calibrating other reference standards and is appropriate for calibrating high-precision analytical balances with a readability as low as 0.01 mg.



Laser etching

Troemner UltraClass Comparison Chart

Weight Class	Equivalent Class Tolerances	Material	Lifetime Guarantee	Positive Calibration Tolerance Guarantee	Standard Laser Serialization
UltraClass Platinum	ANSI/ ASTM Class 000 Class E0*	Alloy 8	X	X	X
UltraClass Gold	ANSI/ ASTM Class 00 OIML Class E1	Alloy 8	X	X	X
UltraClass	ANSI/ ASTM Class 0 & exceeds OIML Class E2	Alloy 8	X	X	

*E0 is a theoretical tolerance that is 50% of OIML R 111 Class E1

ANSI/ASTM E617 Classes

ANSI/ASTM Class 000 - Used as a primary reference for calibrating other reference standards and weights. Class 000 weights are intended to be used in metrology laboratories where the stability of the environment and careful handling are assured. Although very stable, one-piece construction Class 000 weights have no method of adjustment and are not suitable for general laboratory use. Class 000 is 1/3 the tolerance of Class 00 and the uncertainty is the best measurement reported in our NVLAP⁺ scope of accreditation which is guaranteed to be 1/3 the tolerance or better.

ANSI/ASTM Class 00 - Used as a primary reference for calibrating other reference standards and weights. Class 00 weights are intended to be used in metrology laboratories where the stability of the environment and careful handling are assured. Although very stable, one-piece construction Class 00 weights have no method of adjustment and are not suitable for general laboratory use. Class 00 weight tolerances are equal to OIML R 111 E1 tolerances and are tighter than Class 0. The uncertainty is guaranteed to be 1/3 the tolerance.

ANSI/ASTM Class 0 - Used as a primary reference for calibrating other reference standards and weights. Class 0 weights are intended to be used in metrology laboratories where the stability of the environment and careful handling are assured. Although very stable, one-piece construction Class 0 weights have no method of adjustment and are not suitable for general laboratory use. The uncertainty is guaranteed to be 1/3 the tolerance.

ANSI/ASTM Class 1 - Can be used as a reference standard in calibrating other weights and is appropriate for calibrating high-precision analytical balances with a readability as low as 0.1 mg to 0.01 mg.

ANSI/ASTM Class 2 - Appropriate for calibrating high-precision top loading balances with a readability as low as 0.01 g to 0.001 g.

ANSI/ASTM Class 3 - Appropriate for calibrating balances with moderate precision and with a readability as low as 0.1 g to 0.01 g.

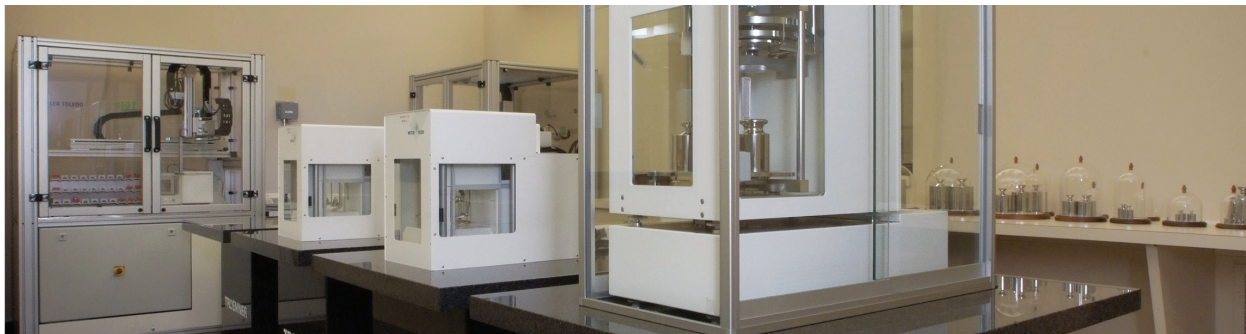

Troemner's Primary Standards Laboratory

ANSI/ASTM Class 4 - For calibration of semi-analytical balances and for student use.

ANSI/ASTM Class 5 - For student laboratory use.

ANSI/ASTM Class 6 - This class meets the specifications of OIML R 111 Class M2.

ANSI/ASTM Class 7 - For rough weighing operations in physical and chemical laboratories, such as force measuring apparatus.

Class E0*

Class E0* - Used as a primary reference for calibrating other reference standards and weights where the stability of the environment and careful handling are assured. Class E0* weights have no method of adjustment and are not suitable for general laboratory use. Class E0* is 1/2 the tolerance of E1 and the uncertainty is the best measurement reported in our NVLAP+ scope of accreditation which is guaranteed to be 1/3 the tolerance or better.

OIML R 111 Classes

OIML Class E1 - Used as a primary reference for calibrating other reference standards and weights where the stability of the environment and careful handling are assured. Class E1 weights have no method of adjustment and are not suitable for general laboratory use. The uncertainty is guaranteed to be 1/3 the tolerance.

OIML Class E2 - Can be used as a reference standard in calibrating other weights and is appropriate for calibrating high-precision analytical balances with a readability as low as 0.1 mg to 0.01 mg.

OIML Class F1 - Appropriate for calibrating high-precision top loading balances with a readability as low as 0.01 g to 0.001 g.

OIML Class F2 - For calibration of semi-analytical balances and for student use.

OIML Class M1, M2, M3 - Economical weights for general laboratory, industrial, commercial, technical and educational use. Typically fabricated from cast iron or stainless steel.

NIST Classes

NIST Class F - Primarily used to test commercial weighing devices by state and local weights and measures officials, device installers, and service technicians. Class F weights may be used to test most accuracy Class III scales, all scales of Class IIII or IIII, and scales not marked with a class designation.

Refer to Troemner's Tolerance Chart on pages 19-20 for specific information on the tolerance of each weight in a given class. Troemner's Uncertainty Chart and Tolerance Chart are also available on www.troemner.com for additional reference.



Tolerance Chart (Maximum Permissible Error)

International Organization of
Legal Metrology Recommendation R 111

Troemner UltraClass Series

	Class E0*	E1	E2	F1	F2	M1	M2	M3	UltraClass Platinum	UltraClass Gold	UltraClass
2000 kg				10 g	30 g	100 g	300 g	1000 g			
1000 kg			1.6 g	5	16	50	160	500			
500 kg			0.8	2.5	8	25	80	250			
300 kg											
200 kg			0.3	1	3	10	30	100			
100 kg			160 mg	0.5	1.6	5	16	50			
50 kg	12.5 mg	25 mg	80	250 mg	800 mg	2.5	8	25	13 mg	25 mg	63 mg
30 kg									7.5	15	38
25 kg									6.25	12.5	31
20 kg	5	10	30	100	300	1	3	10	5.0	10	25
10 kg	2.5	5.0	16	50	160	500 mg	1.6	5	2.5	5.0	13
5 kg	1.3	2.5	8.0	25	80	250	800 mg	2.5	1.3	2.5	6.0
3 kg									0.75	1.5	3.8
2 kg	0.5	1.0	3.0	10	30	100	300	1	0.5	1.0	2.5
1 kg	0.25	0.5	1.6	5.0	16	50	160	500 mg	0.25	0.5	1.3
500 g	0.13	0.25	0.8	2.5	8.0	25	80	250	0.13	0.25	0.60
300 g									0.075	0.15	0.38
200 g	0.05	0.10	0.3	1.0	3.0	10	30	100	0.05	0.10	0.25
100 g	0.025	0.05	0.16	0.5	1.6	5	16	50	0.025	0.05	0.13
50 g	0.015	0.03	0.10	0.3	1.0	3.0	10	30	0.015	0.030	0.060
30 g									0.014	0.026	0.037
20 g	0.013	0.025	0.08	0.25	0.8	2.5	8.0	25	0.013	0.025	0.037
10 g	0.010	0.020	0.06	0.20	0.6	2.0	6.0	20	0.010	0.020	0.025
5 g	0.008	0.016	0.05	0.16	0.5	1.6	5.0	16	0.005	0.010	0.017
3 g									0.005	0.010	0.017
2 g	0.006	0.012	0.04	0.12	0.4	1.2	4.0	12	0.005	0.010	0.017
1 g	0.005	0.010	0.03	0.10	0.3	1.0	3.0	10	0.005	0.010	0.017
500 mg	0.004	0.008	0.025	0.08	0.25	0.8	2.5		0.002	0.003	0.005
300 mg									0.002	0.003	0.005
200 mg	0.003	0.006	0.020	0.06	0.20	0.6	2.0		0.002	0.003	0.005
100 mg	0.003	0.005	0.016	0.05	0.16	0.5	1.6		0.002	0.003	0.005
50 mg	0.002	0.004	0.012	0.04	0.12	0.4			0.002	0.003	0.005
30 mg									0.002	0.003	0.005
20 mg	0.002	0.003	0.010	0.03	0.10	0.3			0.002	0.003	0.005
10 mg	0.002	0.003	0.008	0.025	0.08	0.25			0.002	0.003	0.005
5 mg	0.002	0.003	0.006	0.020	0.06	0.20			0.002	0.003	0.005
3 mg									0.002	0.003	0.005
2 mg	0.002	0.003	0.006	0.020	0.06	0.20			0.002	0.003	0.005
1 mg	0.002	0.003	0.006	0.020	0.06	0.20			0.002	0.003	0.005
0.5 mg	0.002	0.003	0.006						0.002	0.003	0.005
0.2 mg									0.002	0.003	0.005
0.1 mg									0.002	0.003	0.005
0.05 mg									0.002	0.003	0.005

	ANSI/ASTM E617										NIST Handbooks**		
	000	00	0	1	2	3	4	5	6	7	105-1 F	44 Accept	44 Maint
2000 kg					10 g	20 g	40 g	100 g	200 g	300 g	200 g		
1000 kg					5	10	20	50	100	150	100		
500 kg					2.5	5	10	25	50	75	50		
300 kg					1.5	3	6.0	15	30	45	30		
200 kg					1	2	4.0	10	20	30	20		
100 kg					500 mg	1	2.0	5	10	15	10		
50 kg	13 mg	25 mg	63 mg	125 mg	250	500 mg	1.0	2.5	5	7.5	5.0		
30 kg	7.5	15	38	75	150	300	600 mg	1.5	3	4.5	3.0		
25 kg	6.25	12.5	31	62	125	250	500	1.2	2.5	4.5	2.5		
20 kg	5.0	10	25	50	100	200	400	1.0	2	3.8	2.0	750 mg	1500 mg
10 kg	2.5	5.0	13	25	50	100	200	500 mg	1	2.2	1.0	500	1000
5 kg	1.3	2.5	6.0	12	25	50	100	250	500 mg	1.4	0.50	400	800
3 kg	0.75	1.5	3.8	7.5	15	30	60	150	300	1.0	0.30	250	500
2 kg	0.5	1.0	2.5	5.0	10	20	40	100	200	750 mg	0.20	200	400
1 kg	0.25	0.5	1.3	2.5	5.0	10	20	50	100	470	0.10	120	250
500 g	0.13	0.25	0.60	1.2	2.5	5.0	10	30	50	300	70 mg	88	175
300 g	0.075	0.15	0.38	0.75	1.5	3.0	6.0	20	30	210	60	75	150
200 g	0.05	0.10	0.25	0.50	1.0	2.0	4.0	15	20	160	40	50	100
100 g	0.025	0.05	0.13	0.25	0.50	1.0	2.0	9	10	100	20	35	70
50 g	0.015	0.030	0.060	0.12	0.25	0.60	1.2	5.6	7	62	10	20	40
30 g	0.014	0.026	0.037	0.074	0.15	0.45	0.90	4.0	5	44	6.0	15	30
20 g	0.013	0.025	0.037	0.074	0.10	0.35	0.70	3.0	3	33	4.0	10	20
10 g	0.010	0.020	0.025	0.050	0.074	0.25	0.50	2.0	2	21	2.0	8	15
5 g	0.005	0.010	0.017	0.034	0.054	0.18	0.36	1.3	2	13	1.5	5	10
3 g	0.005	0.010	0.017	0.034	0.054	0.15	0.30	0.95	2.0	9.4	1.3	4	8
2 g	0.005	0.010	0.017	0.034	0.054	0.13	0.26	0.75	2.0	7.0	1.1	3	6
1 g	0.005	0.010	0.017	0.034	0.054	0.10	0.20	0.50	2.0	4.5	0.90	2	4
500 mg	0.002	0.003	0.005	0.010	0.025	0.080	0.16	0.38	1.0	3.0	0.72	1.5	3.0
300 mg	0.002	0.003	0.005	0.010	0.025	0.070	0.14	0.30	1.0	2.2	0.61	1.0	2.0
200 mg	0.002	0.003	0.005	0.010	0.025	0.060	0.12	0.26	1.0	1.8	0.54	0.8	1.5
100 mg	0.002	0.003	0.005	0.010	0.025	0.050	0.10	0.20	1.0	1.2	0.43	0.5	1.0
50 mg	0.002	0.003	0.005	0.010	0.014	0.042	0.085	0.16	0.50	0.88	0.35	0.4	0.8
30 mg	0.002	0.003	0.005	0.010	0.014	0.038	0.075	0.14	0.50	0.68	0.30	0.3	0.6
20 mg	0.002	0.003	0.005	0.010	0.014	0.035	0.070	0.12	0.50	0.56	0.26	0.2	0.4
10 mg	0.002	0.003	0.005	0.010	0.014	0.030	0.060	0.10	0.50	0.40	0.21	0.15	0.3
5 mg	0.002	0.003	0.005	0.010	0.014	0.028	0.055	0.080	0.20	0.17	0.17	0.05	0.1
3 mg	0.002	0.003	0.005	0.010	0.014	0.026	0.052	0.070	0.20	0.14	0.14	0.05	0.1
2 mg	0.002	0.003	0.005	0.010	0.014	0.025	0.050	0.060	0.20	0.12	0.12	0.05	0.1
1 mg	0.002	0.003	0.005	0.010	0.014	0.025	0.050	0.050	0.10	0.10	0.10	0.05	0.1
0.5 mg	0.002	0.003	0.005	0.010	0.014	0.025	0.050	0.050	0.10				
0.2 mg	0.002	0.003	0.005	0.010	0.014								
0.1 mg	0.002	0.003	0.005	0.010									
0.05 mg	0.002	0.003	0.005	0.010									



Uncertainties Chart

Uncertainties listed below are for NVLAP+ Accredited calibrations only.

	Troemner CMC**	Class 000 Class E0*	UltraClass Platinum	Class 00 Class E1	UltraClass Gold	Class 0	UltraClass	Class E2	Class 1	Class 2
2000 kg										5 g
1000 kg										3.2
500 kg										1.2
200 kg										0.46
100 kg										0.44
50 kg	2.0 mg	3.0 mg	6.0 mg	6.0 mg	12 mg	15 mg	21 mg	21 mg	25 mg	25 mg
30 kg	1.2	1.8	3	3	6	9	12		15	15
25 kg	0.97	1.6	3	3	3	7	10		12	12
20 kg	0.76	1.2	2.5	2.5	5	6	8	6	10	10
10 kg	0.37	0.4	1	1	2	3	4	3	5	5
5 kg	0.18	0.16	0.5	0.5	1	1.5	3	1.5	2.5	2.5
3 kg	0.11	0.08	0.5	0.5	1	0.9	1.2		1.5	1.5
2 kg	0.072	0.080	0.25	0.25	0.5	0.6	0.8	0.6	1	1
1 kg	0.035	0.050	0.15	0.15	0.3	0.3	0.4	0.3	0.5	0.5
500 g	0.018	0.040	0.060	0.060	.12	0.15	0.2	0.15	0.25	0.25
300 g	0.012	0.030	0.060	0.060	.12	0.090	0.12		0.15	0.15
200 g	0.0073	0.012	0.025	0.025	0.050	0.060	0.08	0.06	0.1	0.1
100 g	0.0038	0.003	0.010	0.010	0.020	0.030	0.04	0.03	0.05	0.05
50 g	0.0022	0.0020	0.007	0.007	0.014	0.015	0.02	0.015	0.025	0.025
30 g	0.0026	0.0020	0.0070	0.0070	0.0140	0.0090	0.012		0.015	0.015
20 g	0.0013	0.0020	0.0060	0.0060	0.0120	0.0080	0.01	0.008	0.015	0.015
10 g	0.0011	0.0015	0.0050	0.0050	0.0100	0.0060	0.008	0.006	0.01	0.01
5 g	0.0009	0.001	0.0030	0.0030	0.0060	0.0040	0.005	0.004	0.007	0.007
3 g	0.0014	0.001	0.003	0.003	0.006	0.004	0.005		0.006	0.006
2 g	0.00075	0.001	0.003	0.003	0.006	0.004	0.005	0.004	0.006	0.006
1 g	0.00054	0.0008	0.0025	0.0025	0.005	0.004	0.005	0.004	0.006	0.006
500 mg	0.00049	0.0005	0.0005	0.0009	0.0009	0.001	0.001	0.001	0.0025	0.0025
300 mg	0.00072	0.0005	0.0005	0.0009	0.0009	0.001	0.001		0.0025	0.0025
200 mg	0.00040	0.0005	0.0005	0.0009	0.0009	0.001	0.001	0.001	0.0025	0.0025
100 mg	0.00040	0.0005	0.0005	0.0009	0.0009	0.001	0.001	0.001	0.0025	0.0025
50 mg	0.00023	0.0005	0.0005	0.0009	0.0009	0.0010	0.001	0.001	0.0025	0.0025
30 mg	0.00020	0.0005	0.0005	0.0009	0.0009	0.0010	0.001		0.002	0.002
20 mg	0.00020	0.0005	0.0005	0.0009	0.0009	0.0010	0.001	0.001	0.002	0.002
10 mg	0.00020	0.0005	0.0005	0.0009	0.0009	0.0010	0.001	0.001	0.002	0.002
5 mg	0.00020	0.0005	0.0005	0.0009	0.0009	0.0010	0.001	0.001	0.002	0.002
3 mg	0.00020	0.0005	0.0005	0.0009	0.0009	0.0010	0.001		0.002	0.002
2 mg	0.00020	0.0005	0.0005	0.0009	0.0009	0.0010	0.001	0.001	0.002	0.002
1 mg	0.00020	0.0005	0.0005	0.0009	0.0009	0.0010	0.001	0.001	0.002	0.002
0.5 mg	0.00020	0.0005	0.0005	0.0009	0.0009	0.0010	0.001	0.001	0.002	0.002
0.2 mg	0.00020	0.0005	0.0005	0.0009	0.0009	0.0010	0.001	0.001	0.002	0.002
0.1 mg	0.00020	0.0005	0.0005	0.0009	0.0009	0.0010	0.001	0.001	0.002	0.002
0.05 mg	0.00020	0.0005	0.0005	0.0009	0.0009	0.0010	0.001	0.001	0.002	0.002

* NVLAP Laboratory Code 105013-0

* E0 is a theoretical tolerance that is 50% of OIML R 111 Class E1

** Calibration and Measurement Capability (best measurement)

	Class 3	Class F1	Class F2	Class 4	Class 5	Class M1	Class 6	Class 7	Class F	Class M2 & M3
2000 kg	5 g	5 g	10 g	10 g	10 g	10 g	50 g	100 g	50 g	
1000 kg	3.2	3.2	5	5	5	15	25	50	25	
500 kg	1.2	1.2	2.5	2.5	2.5	8.0	12	25	12	
200 kg	0.46	0.46	1.0	1.0	1.0	3.0	5.0	10	5.0	
100 kg	0.44	0.44	0.5	0.5	0.5	1.5	2.5	5	2.5	
50 kg	25 mg	25 mg	25 mg	200 mg	200 mg	200 mg	500 mg	500 mg	500 mg	500 mg
30 kg	15			120	120		300	300	300	
25 kg	12			100	100		250	250	250	
20 kg	10	10	10	80	80	80	200	200	200	200
10 kg	5	5	5	40	40	40	100	100	100	100
5 kg	2.5	2.5	2.5	20	20	20	50	50	50	50
3 kg	1.5			12	12		30	30	30	
2 kg	1	1.0	1	8	8	8	20	20	20	20
1 kg	0.5	0.50	0.50	4	4	4	10	10	10	10
500 g	0.25	0.25	0.25	2	2	2	7	7	7	7
300 g	0.15			1.2	1.2		6	6	6	
200 g	0.1	0.10	0.10	0.8	0.8	0.8	4	4	4	4
100 g	0.05	0.05	0.05	0.4	0.4	0.4	2	2	2	2
50 g	0.025	0.025	0.025	0.24	0.24	0.24	1	1	1	1
30 g	0.015			0.18	0.18		0.6	0.6	0.6	
20 g	0.015	0.015	0.015	0.14	0.14	0.14	0.4	0.4	0.4	0.4
10 g	0.01	0.010	0.010	0.1	0.1	0.1	0.2	0.2	0.2	0.2
5 g	0.007	0.0070	0.007	0.07	0.07	0.07	0.15	0.15	0.15	0.15
3 g	0.006			0.06	0.06		0.13	0.13	0.13	
2 g	0.006	0.0060	0.0060	0.05	0.05	0.05	0.11	0.11	0.11	0.11
1 g	0.006	0.0060	0.0060	0.04	0.04	0.04	0.09	0.09	0.09	0.09
500 mg	0.0025	0.0025	0.0025	0.01	0.01	0.01	0.04	0.04	0.04	0.04
300 mg	0.0025			0.01	0.01		0.04	0.04	0.04	
200 mg	0.0025	0.0025	0.0025	0.01	0.01	0.01	0.04	0.04	0.04	0.04
100 mg	0.0025	0.0025	0.0025	0.01	0.01	0.01	0.04	0.04	0.04	0.04
50 mg	0.0025	0.0025	0.0025	0.01	0.01	0.01	0.04	0.04	0.04	
30 mg	0.002			0.01	0.01		0.04	0.04	0.04	
20 mg	0.002	0.002	0.0020	0.01	0.01	0.01	0.04	0.04	0.04	
10 mg	0.002	0.002	0.0020	0.01	0.01	0.01	0.04	0.04	0.04	
5 mg	0.002	0.002	0.0020	0.01	0.01	0.01	0.02	0.02	0.02	
3 mg	0.002			0.01	0.01		0.02	0.02	0.02	
2 mg	0.002	0.002	0.0020	0.01	0.01	0.01	0.02	0.02	0.02	
1 mg	0.002	0.002	0.0020	0.01	0.01	0.01	0.02	0.02	0.02	
0.5 mg	0.002	0.002	0.0020	0.01	0.01	0.01	0.02	0.02	0.02	
0.2 mg	0.002	0.002	0.0020	0.01	0.01	0.01	0.02	0.02	0.02	
0.1 mg	0.002	0.002	0.0020	0.01	0.01	0.01	0.02	0.02	0.02	
0.05 mg	0.002	0.002	0.0020	0.01	0.01	0.01	0.02	0.02	0.02	



Certificate Options

Variety of Weight Certificates

Troemner's calibration and certificate options are designed to provide the customer a range of choices in measurement precision, quality of data, and compliance to calibration and quality standards.

The choices are as follows:

NVLAP⁺ Accredited Mass Code Report of Mass Values

Troemner Mass Code Report of Mass Values is available for one-piece weights in ANSI/ASTM E617 Class 000, 00, 0 and Class E0*, OIML R 111 E1, and E2, and is the same report one would receive if weights were calibrated directly by NIST. This calibration delivers uncertainties which are the lowest available by a commercial laboratory matching those of many National Metrology Institutes. Troemner utilizes a calibration software program provided by NIST to perform a calibration that involves a series of interdependent comparisons. Troemner's primary standards are used for this calibration procedure. The calibration provides a high level of confidence that the measurements are in statistical control. This multi-page report of mass values is very detailed and includes statistical analysis including all measurement results, uncertainty calculations, as well as F and t test values. This certificate also includes Density Determination and Magnetic Susceptibility Determination Calibrations.

NVLAP⁺ Accredited Primary Reference Certificate

This certificate is available for one-piece weights in ANSI/ASTM Class 000, 00, 0 and Class E0*, OIML R 111 E1 and E2, and contains all of the information as the standard NVLAP⁺ Accredited Certificate as well as the Density Determination and Magnetic Susceptibility Determination Calibrations. Troemner's secondary standards are used for this calibration procedure.

NVLAP⁺ Accredited Certificate

The NVLAP⁺ Accredited Certificate provides compliance in both measurement process and data reported to the customer to meet a variety of standards including NVLAP Handbook 150-2, ISO/IEC 9000, ISO/IEC 17025, FDA, GMP, GLP, DOD, ANSI/NCSL Z540-1, and nuclear requirements. Troemner's NVLAP Laboratory Code is 105013-0. The NIST administered National Voluntary Laboratory Accreditation Program (NVLAP⁺) approves, through periodic audits, all processing and weighing procedures, as well as certificate format and content. Calibration procedures vary by tolerance class requested. For example, for higher accuracy classes such as Troemner UltraClass Series, ANSI/ASTM Class 000, 00, 0, and 1, Class E0*, OIML R 111 Class E1, E2, and F1, Troemner performs a multiple weighing procedure utilizing our secondary working standards to determine the mass of a customer's weight.

NVLAP⁺ Accredited Density Determination Calibration

Troemner's mass metrology laboratory can determine the actual density of one-piece mass standards that range in size from 1 g through 5 kg. Troemner is the only private NIST/NVLAP⁺ accredited laboratory in the United States for this mass calibration service. Troemner provides this service to reduce the uncertainty of calibrating one-piece precision ANSI/ASTM Class 000, 00, and 0 and Class E0*, OIML R 111 Class E1, and E2 weights. The process is highly recommended for one-piece weights used as reference standards. Utilizing a balance, a series of measurements are compared to a NIST traceable density standard immersed in water to determine the density value. The data found in this certificate will enable you to make the proper buoyancy corrections when performing calibrations on other weights. This certificate provides you with the information you need for working in true mass. Density Determination Calibration is also included in the NVLAP⁺ Accredited Mass Code Report of Mass Values and the NVLAP⁺ Accredited Primary Reference Certificate.

* NVLAP Laboratory Code 105013-0

*E0 is a theoretical tolerance that is 50% of OIML R 111 Class E1

NVLAP+ Accredited Magnetic Susceptibility Determination Calibration

Troemner has the capability of measuring the magnetic field intensity and the potential magnetic susceptibility of stainless steel one-piece mass standards sized 1 g through 10 kg. Troemner is the only private accredited laboratory in the world for this mass calibration service. This process is recommended for one-piece weights used as reference standards to demonstrate the weights meet the required specifications for magnetism. Magnetic Susceptibility Determination Calibration is also included in the NVLAP+ Accredited Mass Code Report of Mass Values and the NVLAP+ Accredited Primary Reference Certificate.

The NVLAP+ Accredited Certificates include:

- Date of calibration
- Serial number and ID number
- Equipment and standards used during the calibration and their calibration due dates
- Accuracy class
- True mass value (mass in a vacuum)
- Conventional mass value ("As Found" and "As Left" for recalibration)
- Conventional mass correction ("As Found" and "As Left" for recalibration)
- Uncertainty of the measurement process for each weight
- Environmental conditions during test
- Construction and assumed density of weights
- Weight calibration procedures used
- Statement of traceability to NIST
- Helpful list of terms and definitions

Traceable Certificate

The Traceable Certificate is designed for those laboratories and companies that require traceability, but do not need to meet any stringent regulatory requirements. The Traceable Certificate measurement process is based on a single standard and utilizes one series of comparisons.

Information includes:

- Date of calibration
- Serial number and ID number
- Accuracy class
- The nominal value of the weight
- Mass correction, tolerance and uncertainty
- As Found and As Left tolerance status
- Statement of traceability to NIST



Certificate Options

Certificate Options Comparison Chart

The chart below depicts the varying features among the certificate options of an individual weight or weight set.

	NVLAP+ Accredited Mass Code Report of Mass Values	NVLAP+ Accredited Primary Reference Certificate	NVLAP+ Accredited Certificate	Traceable Certificate
Name, Address, P.O. Number	X	X	X	X
Date of Calibration	X	X	X	X
Serial Number	X	X	X	X
Equipment and Standards Used				
Balance – Calibration Due Dates	X	X	X	
Standards – Calibration Due Dates	X	X	X	
Standards – Corrections	X			
Accuracy Class	X	X	X	X
Nominal Value	X	X	X	X
Conventional Mass Value				
“As Found Data” *	X	X	X	
“As Left Data”	X	X	X	
Conventional Mass Correction				
“As Found Data” *	X	X	X	X
“As Left Data”	X	X	X	X
True Mass Value (Mass in a Vacuum)				
“As Found Data” *	X	X	X	
“As Left Data”		X	X	
Density Determination	X	X		
Magnetic Susceptibility Determination	X	X		

	NVLAP+ Accredited Mass Code Report of Mass Values	NVLAP+ Accredited Primary Reference Certificate	NVLAP+ Accredited Certificate	Traceable Certificate
Uncertainty of Measurement Process	X	X	X	X
Environmental Conditions During Test	X	X	X	
Construction and Density of Weights	X	X	X	X
Calibration Procedures Used	X	X	X	
Statement of Traceability to NIST	X	X	X	X
Measurement Assurance Data	X			
Helpful List of Terms and Definitions		X	X	
One Series of Comparisons Using a Single Standard		ANSI/ASTM Class 5,6 OIML Class M1, M2 NIST Class F		All Classes
Multiple Comparisons Using a Check Standard	One-Piece Weights ANSI/ASTM Class 000, 00, 0 Class E0*, OIML R 111 Class E1, E2		ANSI/ASTM Class 0, 1, 2, 3, 4 OIML Class E1, E2, F1, F2	
Comparison Method Data	X			
Meets ISO/IEC 17025, FDA, GMP, DOD, ANSI/NCSL Z540-1, NCR 10CFR50 Appendix B	X	X	X	



Analytical Precision Weights

Troemner UltraClass Platinum, UltraClass Gold, and UltraClass and ANSI/ASTM E617 Class 000, 00, 0, 1, 2, 3, 4



General Information

Troemner Analytical Precision Metric Weights are available in Troemner UltraClass Platinum, UltraClass Gold, and UltraClass and ANSI/ASTM E617 Class 000, 00, 0, 1, 2, 3 and 4. Troemner Analytical Precision Avoirdupois Weights are available in ANSI/ASTM E617 Class 1, 2, 3, and 4. Analytical Precision Weights meet or exceed specifications as defined in the ANSI/ASTM E617 standard.

The weights are manufactured of the finest stainless steels available, including Troemner Alloy 8 Stainless Steel, which is available exclusively through Troemner. This unique material possesses closely controlled density (8.03 g/cm³), extremely low magnetic properties, good stability, and resistance to corrosion. Alloy 8 is the finest grade of stainless steel available and is similar to material originally specified in the manufacture of 1 kg state lab primary standards.

Weights are designed so the specifications on surface finish, markings, construction, material density, and magnetic properties become more restrictive as the weight tolerances decrease in order to enable the weight to maintain its tolerance over time. These weights are designed for your most demanding weighing applications.

Suggested Markets

Suggested Markets for Analytical Precision Weights include, but are not limited to, pharmaceutical, biotech, nanotechnology, life science, forensic and nuclear industries.

Why UltraClass?

Available exclusively from Troemner, UltraClass weights are the most precise two-piece weights available with weight tolerances that equal or exceed ANSI/ASTM E617 Class 000, 00, and 0 tolerances. Troemner UltraClass weights combine high precision with the advantage of two-piece construction (1 g and larger), avoiding costly replacement issues associated with one-piece weights. To learn more about available weight classes and suggested weight applications, please see the "Selecting Weight Classes" section beginning on page 15.

Tolerance Classes

ANSI/ASTM E617 classes with small numerical designations represent smaller tolerances. Refer to Troemner's Tolerance Chart on pages 19-20 for specific information on the tolerance of each weight in a given class. Troemner's Tolerance Chart is also available on www.troemner.com for additional reference.

Construction and General Shape

Milligram Weights - Weights 500 mg and below are made of sheet metal and are one-piece construction with one side turned up to make them easy to handle with forceps. Milligram weights are marked with their nominal value with the exception of Class 000, 00, and 0.

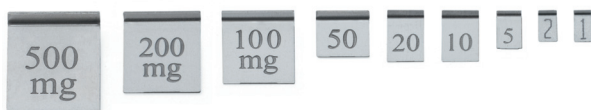

Milligram Wire Weights - Troemner Precision Weights 500 mg and below are also available in wire construction sheet metal with the shape denoting the nominal value according to the table below. These weights are constructed with one end turned up to allow for easy handling with forceps. To order milligram wire weights, specify the Troemner part number followed by “-wire”.



Shape	Denomination
Pentagon	500 mg, 50 mg, 5 mg
Circle	300 mg, 30 mg, 3 mg
Square	200 mg, 20 mg, 2 mg
Triangle	100 mg, 10 mg, 1 mg

Gram Weights - Troemner Analytical Precision Weights 1 g and larger consist of a body and a lifting knob. The lifting knob is specifically designed for use with forceps or some other lifting device. Weight bottoms are slightly recessed to expose the smallest possible area to wear. Each weight (except Class 000, 00, and 0 weights) is marked with its nominal value.

Troemner Analytical Precision Weights are available in either one-piece or two-piece construction. One-piece construction indicates the weight is manufactured from a single uniform piece of stainless steel, the weight has no other material added to it, and it has no method of adjustment other than removing material by polishing. Class 000, 00, and 0 weights 1 g and larger are of one-piece construction, Weights 1 g through 20 kg are constructed with Troemner Alloy 8 Stainless Steel, which has a consistent density.

Two-piece construction means the weight is made of multiple pieces of stainless steel. Troemner UltraClass Platinum, UltraClass Gold, UltraClass and ANSI/ASTM Class 1, 2, 3 and 4 weights 1 g and larger are produced from two pieces of material. The body of the weight is the primary piece and the knob of the weight is the secondary piece. The knob has a thread that screws into the body and is tightened. There is a cavity below the knob thread in the body which contains adjusting material, typically the same material from which the weight is made.

Top of weight is marked with nominal value



Tapered neck allows for easy handling by forceps or lifter

Highly polished mirror-like finish allows scratches and foreign matter on the weight to be easily seen

Bottom of weights are recessed to reduce wear

Surface Finish

All surfaces are polished to a perfect, mirror-like finish and conform to specifications in ANSI/ASTM E617. Surface finish specifications are available on www.troemner.com for additional reference.

Material Specifications for Class 000, 00, and 0 Weights

Weight Range	Base Material	Density
25 kg — 50 kg	316 Stainless Steel	7.95 g/cm ³ at 20° C
1 g — 20 kg	Troemner Alloy 8	8.03 g/cm ³ at 20° C
5 mg — 500 mg*	304 Stainless Steel	7.95 g/cm ³ at 20° C
3 mg and smaller	3003-H14 Aluminum	2.7 g/cm ³ at 20° C

All weights Class 000, 00, and 0 are one-piece weights.

Material Specifications for Troemner UltraClass Platinum, UltraClass Gold, and UltraClass and Class 1, 2, 3 and 4

Weight Range	Base Material	Density
2 kg — 50 kg	316 Stainless Steel	7.95 g/cm ³ at 20° C
1 g — 1 kg	Troemner Alloy 8	8.03 g/cm ³ at 20° C
5 mg — 500 mg*	304 Stainless Steel	7.95 g/cm ³ at 20° C
3 mg and smaller	3003-H14 Aluminum	2.7 g/cm ³ at 20° C

Weights 1 g and larger are two-piece weights. Milligram weights are one-piece weights.

*30 mg weights are aluminum



Metric Analytical Precision Weights

Weight Sets



Weight Set Configuration Information

Troemner Analytical Precision Weight Sets are supplied in a 5-2-2-1 series unless a 5-3-2-1 series is specified. 5-2-2-1 series means that weights beginning with a "2" are doubled in each decade and weights beginning with a "5" and "1" are single in each decade. For example, a set with 5-2-2-1 series from 50 g to 1 g includes the following: one 50 g, two 20 g, one 10 g, one 5 g, two 2 g, and one 1 g. A 50 g to 1 g set in a 5-3-2-1 series would contain one 50 g, one 30 g, one 20 g, one 10 g, one 5 g, one 3 g, one 2 g, and one 1 g. If a 5-3-2-1 set is required, please contact a Troemner Sales Representative at 800-249-5554 or troemner@troemner.com to discuss your specific needs.

NOTE: The following weight set table shows each weight set in a 5-2-2-1 series.

Large Metric Sets

Weight sets where the largest weight is 1 kg and above are supplied in a “case within a case.” Inside a handcrafted wood case, there is a compartment holding a polycarbonate case containing weights 500 g and below. 1 kg and 2 kg weights are held in their individual polycarbonate weight cases inside a felt-lined cutout. For weights 5 kg and larger, a felt-lined compartment for each weight exists within the wood case (50 kg weights are not supplied in a case, however a case can be purchased separately). There are also compartments for lifters and forceps supplied with each set. Weight sets where the largest weight is 10 kg and above are supplied with a Complete Accessory Kit which includes a microfibre cloth, nylon glove, small and wide brushes, and forceps.



Weight Set	Part #*	50 kg	30 kg	25 kg	20 kg	10 kg	5 kg	2 kg	1 kg	500 g	200 g	100 g	50 g	20 g	10 g	5 g	2 g	1 g	500 mg	200 mg	100 mg	50 mg	20 mg	10 mg	5 mg	2 mg	1 mg	
50 kg — 1 g	7200	1			2	1	1	2	1	1	2	1	1	2	1	1	2	1										
50 kg — 1 mg	7201	1			2	1	1	2	1	1	2	1	1	2	1	1	2	1	1	2	1	1	2	1	1	2	1	
30 kg — 1 g	7202		1		1	1	1	2	1	1	2	1	1	2	1	1	2	1										
30 kg — 1 mg	7203		1		1	1	1	2	1	1	2	1	1	2	1	1	2	1	1	2	1	1	2	1	1	2	1	
25 kg — 1 g	7204			1	1	1	1	2	1	1	2	1	1	2	1	1	2	1										
25 kg — 1 mg	7205			1	1	1	1	2	1	1	2	1	1	2	1	1	2	1	1	2	1	1	2	1	1	2	1	
20 kg — 1 g	7206				1	1	1	2	1	1	2	1	1	2	1	1	2	1										
20 kg — 1 mg	7207				1	1	1	2	1	1	2	1	1	2	1	1	2	1	1	2	1	1	2	1	1	2	1	
10 kg — 1 g	7208					1	1	2	1	1	2	1	1	2	1	1	2	1										
10 kg — 1 mg	7209					1	1	2	1	1	2	1	1	2	1	1	2	1	1	2	1	1	2	1	1	2	1	
5 kg — 1 g	7210						1	2	1	1	2	1	1	2	1	1	2	1										
5 kg — 1 mg	7211						1	2	1	1	2	1	1	2	1	1	2	1	1	2	1	1	2	1	1	2	1	
2 kg — 1 g	7212							2	1	1	2	1	1	2	1	1	2	1										
2 kg — 1 mg	7213							2	1	1	2	1	1	2	1	1	2	1	1	2	1	1	2	1	1	2	1	
2 kg — 1 g	7214							1	1	1	2	1	1	2	1	1	2	1										
2 kg — 1 mg	7215							1	1	1	2	1	1	2	1	1	2	1	1	2	1	1	2	1	1	2	1	
1 kg — 1 g	7216								1	1	2	1	1	2	1	1	2	1										
1 kg — 1 mg	7217								1	1	2	1	1	2	1	1	2	1	1	2	1	1	2	1	1	2	1	

* For creating a complete part #, refer to page 38.

NOTE: The following weight set table shows each weight set in a 5-2-2-1 series.

Medium Metric Sets

Weight sets where the largest weight is 500 g and below are supplied in attractive, durable, high quality, **patented** polycarbonate cases with a compartment for each weight within the case. There is also a compartment for a brush, forceps and a USB Flash Drive which contains the electronic certificate. (Weight sets ordered with Traceable Certificate will not have a USB Flash Drive; a printed certificate will be sent with the weights.) The cases are designed specific to the size and style of the weight so each weight fits snug in its compartment. Custom bumpers rest above each weight to assure weights are held securely in place.



Weight Set	Part #*	500 g	200 g	100 g	50 g	20 g	10 g	5 g	2 g	1 g	500 mg	200 mg	100 mg	50 mg	20 mg	10 mg	5 mg	2 mg	1 mg	
500 g — 1 g	7218	1	2	1	1	2	1	1	2	1										
500 g — 1 mg	7219	1	2	1	1	2	1	1	2	1	1	2	1	1	2	1	1	2	1	1
200 g — 1 g	7220		2	1	1	2	1	1	2	1										
200 g — 1 mg	7221		2	1	1	2	1	1	2	1	1	2	1	1	2	1	1	2	1	1
200 g — 1 g	7222		1	1	1	2	1	1	2	1										
200 g — 1 mg	7223		1	1	1	2	1	1	2	1	1	2	1	1	2	1	1	2	1	1
100 g — 1 g	7224			1	1	2	1	1	2	1										
100 g — 100 mg	7225			1	1	2	1	1	2	1	1	2	1							
100 g — 10 mg	7226			1	1	2	1	1	2	1	1	2	1	1	2	1				
100 g — 5 mg	7227			1	1	2	1	1	2	1	1	2	1	1	2	1	1			
100 g — 1 mg	7228			1	1	2	1	1	2	1	1	2	1	1	2	1	1	2	1	1
50 g — 1 g	7229				1	2	1	1	2	1										
50 g — 100 mg	7230				1	2	1	1	2	1	1	2	1							
50 g — 10 mg	7231				1	2	1	1	2	1	1	2	1	1	2	1				
50 g — 5 mg	7232				1	2	1	1	2	1	1	2	1	1	2	1	1			
50 g — 1 mg	7233				1	2	1	1	2	1	1	2	1	1	2	1	1	2	1	1
20 g — 1 g	7234					1	1	1	2	1										
20 g — 100 mg	7235					1	1	1	2	1	1	2	1							
20 g — 10 mg	7236					1	1	1	2	1	1	2	1	1	2	1				
20 g — 5 mg	7237					1	1	1	2	1	1	2	1	1	2	1	1			
20 g — 1 mg	7238					1	1	1	2	1	1	2	1	1	2	1	1	2	1	1

* For creating a complete part #, refer to page 38.

NOTE: The following weight set table shows each weight set in a 5-2-2-1 series.

Small Metric Sets

Weight sets where the largest weight is 5 g and below are supplied in attractive, durable, high quality, **patented** polycarbonate weight cases with a compartment for each weight within the case. There are also compartments for the forceps and brush. Each Milligram Case includes an inner lid that keeps weights clean and secure when in use or during shipping.



Weight Set	Part #*	5 g	2 g	1 g	500 mg	200 mg	100 mg	50 mg	20 mg	10 mg	5 mg	2 mg	1 mg	0.5 mg	0.2 mg	0.1 mg	0.05 mg
5 g — 10 mg	7242	1	2	1	1	2	1	1	2	1							
5 g — 1 mg	7243	1	2	1	1	2	1	1	2	1	1	2	1				
500 mg — 10 mg	7239				1	2	1	1	2	1							
500 mg — 1 mg	7240				1	2	1	1	2	1	1	2	1				
0.5 mg — 0.05 mg	7241													1	2	1	1

* For creating a complete part #, refer to page 38.





Metric Analytical Precision Weights

Individual Weights

Metric Individual Weights

Individual weights 1 mg through 10 kg are supplied in attractive, durable, high quality, **patented** polycarbonate cases with custom inserts designed specifically for the style and size of the weight. The polycarbonate cases have a locking lid and a custom bumper designed to hold the weight securely in place. Protective cases in either polypropylene or wood are available for weights larger than 10 kg at an additional cost. Optional wood cases are available for weights 1 mg and larger. Wood cases for weights sized 2 kg through 1 mg are designed to hold a weight inside a polycarbonate individual case. This "case-in-a-case" feature guarantees the ultimate protection of your weight.

Weight	Part #*	Weight	Part #*
1000 kg	7000	500 g	7014
500 kg	7001	300 g	7015
300 kg	7002	200 g	7016
200 kg	7003	100 g	7017
100 kg	7004	50 g	7018
50 kg	7005	30 g	7019
30 kg	7006	20 g	7020
25 kg	7007	10 g	7021
20 kg	7008	5 g	7022
10 kg	7009	3 g	7023
5 kg	7010	2 g	7024
3 kg	7011	1 g	7025
2 kg	7012		
1 kg	7013		

* For creating a complete part #, refer to page 38.

Metric Individual Milligram Weights

Metric Individual Milligram Weights are available in sheet metal or wire construction. Sheet metal weights are shipped unless "-wire" is indicated at the end of the part number upon ordering.

Weight	Part #*	Weight	Part #*
500 mg	7026	5 mg	7034
300 mg	7027	3 mg	7035
200 mg	7028	2 mg	7036
100 mg	7029	1 mg	7037
50 mg	7030	0.5 mg	7043
30 mg	7031	0.2 mg	7044
20 mg	7032	0.1 mg	7045
10 mg	7033	0.05 mg	7046

* For creating a complete part #, refer to page 38.





Avoirdupois Analytical Precision Weights

Weight Sets

Avoirdupois Sets

Troemner Avoirdupois Weight Sets are supplied in a case. A hand crafted wood case holds larger individual weights in felt-lined compartments and an additional compartment holds a polypropylene case to hold smaller weights. There are also compartments for lifters and forceps supplied with each weight set. (Avoirdupois weights are available only in Class 1, 2, 3, or 4 with a NVLAP+ Accredited or Traceable Certificate.)



Weight Set	Part #*	50 lb	30 lb	25 lb	20 lb	10 lb	5 lb	2 lb	1 lb	8 oz	4 oz	2 oz	1 oz	1/2 oz	1/4 oz	1/8 oz	1/16 oz	1/32 oz	0.5 lb	0.2 lb	0.1 lb	0.05 lb	0.02 lb	0.01 lb	0.005 lb	0.002 lb	0.001 lb	
50 lb — 1/32 oz	6200	1			2	1	1	2	1	1	1	1	1	1	1	1	1	2										
50 lb — 0.001 lb	6201	1			2	1	1	2	1										1	2	1	1	2	1	1	2	1	
30 lb — 1/32 oz	6202		1		1	1	1	2	1	1	1	1	1	1	1	1	1	2										
30 lb — 0.001 lb	6203		1		1	1	1	2	1										1	2	1	1	2	1	1	2	1	
25 lb — 1/32 oz	6204			1	1	1	1	2	1	1	1	1	1	1	1	1	1	2										
25 lb — 0.001 lb	6205			1	1	1	1	2	1										1	2	1	1	2	1	1	2	1	
20 lb — 1/32 oz	6206				1	1	1	2	1	1	1	1	1	1	1	1	1	2										
20 lb — 0.001 lb	6207				1	1	1	2	1										1	2	1	1	2	1	1	2	1	
10 lb — 1/32 oz	6208					1	1	2	1	1	1	1	1	1	1	1	1	2										
10 lb — 0.001 lb	6209					1	1	2	1										1	2	1	1	2	1	1	2	1	
5 lb — 1/32 oz	6210						1	2	1	1	1	1	1	1	1	1	1	2										
5 lb — 0.001 lb	6211						1	2	1										1	2	1	1	2	1	1	2	1	
2 lb — 1/32 oz	6212							1	1	1	1	1	1	1	1	1	1	2										
2 lb — 0.001 lb	6213							1	1										1	2	1	1	2	1	1	2	1	
1 lb — 1/32 oz	6214								1	1	1	1	1	1	1	1	1	2										
1 lb — 0.001 lb	6215								1										1	2	1	1	2	1	1	2	1	
8 oz — 1/32 oz	6216									1	1	1	1	1	1	1	1	2										
0.5 lb — 0.001 lb	6217																		1	2	1	1	2	1	1	2	1	

* For creating a complete part #, refer to page 38.

* NVLAP Laboratory Code 105013-0



Avoirdupois Analytical Precision Weights

Individual Weights

Avoirdupois Individual Weights

Troemner Avoirdupois Individual Weights are not supplied in cases. Protective cases in either wood or polypropylene are available at an additional cost. (Avoirdupois weights are available only in Class 1, 2, 3, or 4 with a NVLAP+ Accredited or Traceable Certificate.)

Weight	Part #*	Weight	Part #*
50 lb	6004	8 oz	6026
30 lb	6005	4 oz	6027
25 lb	6006	2 oz	6028
20 lb	6007	1 oz	6029
10 lb	6008	1/2 oz	6030
5 lb	6009	1/4 oz	6031
4 lb	6010	1/8 oz	6032
3 lb	6011	1/16 oz	6033
2 lb	6012	1/32 oz	6034
1 lb	6013	1/64 oz	6035
0.5 lb	6014	0.5 oz	6036
0.3 lb	6015	0.3 oz	6037
0.2 lb	6016	0.2 oz	6038
0.1 lb	6017	0.1 oz	6039
0.05 lb	6018	0.05 oz	6040
0.03 lb	6019	0.03 oz	6041
0.02 lb	6020	0.02 oz	6042
0.01 lb	6021	0.01 oz	6043
0.005 lb	6022		
0.003 lb	6023		
0.002 lb	6024		
0.001 lb	6025		



* For creating a complete part #, refer to page 38.

* NVLAP Laboratory Code 105013-0



Creating Your Complete Analytical Precision Weight Part Number

1. Select a Part

Select a part # from the preceding tables for each product that you wish to order.

2. Select an Available Class Designation

Select a class designation from the following tables. For help selecting the correct class for your application, please review the "Selecting Weight Classes" section beginning on page 15.

Troemner Classes	Code	ANSI/ASTM E617 Classes	Code	ANSI/ASTM E617 Classes	Code
UltraClass Platinum	UCP	Class 000*	003	Class 2	2
UltraClass Gold	UCG	Class 00*	002	Class 3	3
UltraClass	0	Class 0	00	Class 4	4
		Class 1	1		

3. Select a Certificate Code (optional)

Select a certificate code from the following table. To learn more about Troemner's certificates, please review the "Certificate Options" section beginning on page 23.

Available Certificates	Code
NVLAP+ Accredited Mass Code Report of Mass Values	MC
NVLAP+ Accredited Primary Reference Certificate	PR
NVLAP+ Accredited Certificate	W
Traceable Certificate	T
NVLAP+ Accredited Density Determination Calibration	WDC-1111+++
NVLAP+ Accredited Magnetic Susceptibility Determination Calibration	MAGCAL-1111+++

+++ Reference part number on order as a separate line item

4. Create Your Complete Part Number(s)

Specify the Part Number + Class Code + Certificate Code (optional) for each product that you wish to order.



* NVLAP Laboratory Code 105013-0



Analytical Precision Weights

Weight Cases

Weight Cases

Troemner can provide you with the weight cases you need for proper handling and protection of your Analytical Precision Weights and Weight Sets. Please contact a Troemner Sales Representative at [800-249-5554](tel:800-249-5554) or troemner@troemner.com for specific information on new cases, replacement cases, or special cases you need to store and protect your weights.

Polycarbonate Cases for Weight Sets

Case holds Weight Sets 500 g and below

Troemner's new **patented** Weight Set Case is constructed of high quality polycarbonate. The case is designed for Analytical Precision Weight Sets where the largest weight is 500 g or below. Case includes an inner lid over the milligram weights that keeps the weights clean and secure when in use and during shipping. This case only holds metric weights with "5-2-2-1" configuration. Avoirdupois weights or any other style of weights are supplied in a custom case. There are also compartments for the forceps and brush (**not included**).



Dimensions: 8" L x 7" W x 3.5" H
(20.32 cm x 17.78 cm x 8.89 cm)

Weight	Part #
500 g — 1 mg	WSCA—5001

Polycarbonate Cases for Weight Sets

Case holds Weight Sets 5 g and below

Troemner weight sets where the largest weight is 5 g and below are supplied in an attractive, durable, high quality, **patented** polycarbonate weight case. Each case includes a compartment for each weight within the case. Case includes an inner lid that keep weights clean and secure when in use and during shipping. There are also compartments for the forceps and brush (**not included**).



Dimensions: 3.5" Dia x 4.5" H
(8.9 cm x 11.4 cm)

Weight	Part #
500 mg — 1 mg	WSCA—0005
5 g — 1 mg	WSCA—0050

www.troemner.com • 800-249-5554

Wood Cases for Weight Sets

Troemner's Wood Weight Set Cases are manufactured from oak. They hold weight sets where the largest weight is 1 kg or above. Inside the wood case is a compartment holding a polycarbonate set case containing weights 500 g and below. 1 kg and 2 kg weights are held in their individual polycarbonate weight cases inside the felt-lined compartment. For weights 5 kg, 10 kg, and 20 kg, a felt-lined compartment for each weight exists within the wood case (50 kg weights are not supplied in a case, however, a case can be purchased separately).

Weight	Part #
20 kg — 1 mg	WSWA—0001
10 kg — 1 mg	WSWA—0002
5 kg — 1 mg	WSWA—0003
2 kg — 1 mg	WSWA—0004
200 g — 1 mg	WSWA—0005

Heavy-Duty Cases for Weight Sets

Heavy-Duty Cases are tough, lightweight, rugged and designed to protect your weight set under any shipping circumstance. The dent and shatter resistant resin ensures weights are kept safe and secure. Each case is lined in high quality ethafoam with custom cutouts for weights and cases. The case is manufactured with easy press and pull latches and durable soft grip handles.

Weight	Part #
20 kg — 1 mg	SSCA—20000*
10 kg — 1 mg	SSCA—10000
5 kg — 1 mg	SSCA—05000
(2) 2 kg — 1 mg	SSCA—02200
2 kg — 1 mg	SSCA—02000
1 kg — 1 mg	SSCA—01000
500 g — 1 mg	SSCA—00500

* Weight case includes wheels and a telescoping handle



5 kg through 1 mg case shown
Dimensions: 16" L x 13" W x 7.5" H
(40.6 cm x 33.0 cm x 19.1 cm)



2 kg and 1 kg case shown
Dimensions: 16.2" L x 12.7" W x 6.6" H
(41.2 cm x 32.3 cm x 16.8 cm)

Visit our website at www.troemner.com for additional case dimensions.

Aluminum Cases for Weight Sets

Aluminum cases are strong, lightweight, and extremely durable. Each case is lined in high quality ethafoam with custom cutouts for weights or cases. Cases are designed with positive locking latches and each case is equipped with a triple digit combination lock.

Visit our website at www.troemner.com for additional case dimensions.

Weight	Part #
10 kg — 1 mg	ASCA—10000
5 kg — 1 mg	ASCA—05000
(2) 2 kg — 1 mg	ASCA—02200
2 kg — 1 mg	ASCA—02000
1 kg — 1 mg	ASCA—01000
500 g — 1 mg	ASCA—00500



10 kg through 1 mg case shown
Dimensions: 18" L x 13" W x 8" H
(45.7 cm x 33.0 cm x 20.3 cm)

Polycarbonate Cases for Individual Weights

Case holds weights 10 kg and 5 kg

Troemner's Kilogram Cases are designed to securely hold, protect, and transport your weights sized 10 kg and 5 kg. Each case has a comfortable carrying handle, a recessed grip for removing the lid, side latches for securing the lid in place, and a color-coded insert. Urethane bumpers, both inside the lid and on the bottom of the case, gently hold the weight in place.

Weight	Part #
10 kg	SWCA—10000
5 kg	SWCA—5000



Dimensions: 6" Dia. x 10.25" H
(15.2 cm x 26.0 cm)

Polycarbonate Cases for Individual Weights

Case holds weights 2 kg through 1 g

Troemner's **patented** Individual Polycarbonate Cases are designed to securely hold and protect your weights sized 2 kg through 1 g. As the lid is rotated open, the color-coded insert and weight move with the lid. This prevents the urethane bumper from rubbing on the weight, further protecting your weight's calibration.

Weight	Part #
2 kg	SWCA—2000
1 kg	SWCA—1000
500 g	SWCA—0500
300 g	SWCA—0300
200 g	SWCA—0200
100 g	SWCA—0100
50 g	SWCA—0050
30 g	SWCA—0030
20 g	SWCA—0020
10 g	SWCA—0010
5 g	SWCA—0005
3 g	SWCA—0003
2 g	SWCA—0002
1 g	SWCA—0001



Small size holds 200 g through 1 g
Dimensions: 2" Dia. x 2.5" H
(5.1 cm x 6.4 cm)

Large size holds 2 kg through 300 g
Dimensions: 3.5" Dia. x 4.5" H
(8.9 cm x 11.4 cm)

Polycarbonate Cases for Individual Weights

Case holds weights 500 mg through 1 mg

Troemner's **patented** Milligram Cases hold up to seven sheet metal or wire weights sized 500 mg through 1 mg. Each Milligram Case includes an inner lid that keeps weights clean and secure when in use and during shipping.

Weight	Part #
Up to (7) mg weights	SWCA—0000



Assembled dimensions: 2" Dia. x 2.5" H
(5.1 cm x 6.4 cm)

Polypropylene Cases for Individual Weights

Troemner's Polypropylene Individual Weight Cases are made of high impact plastic. Cases are made with reinforced metal edges and corners. They also have a padded carrying handle to ensure proper handling during transport.

Visit our website at www.troemner.com for additional case dimensions.

Weight	Part #
50 kg	TWA—100—50KG
30 kg	TWA—100—30KG
25 kg	TWA—100—25KG
20 kg	TWA—100—20KG



25 kg case shown
Dimensions: 8" L x 8" W x 9" H
(20.3 cm x 20.3 cm x 22.9 cm)

Wood Cases for Individual Weights

Individual Wood Cases are made of oak construction with a foam insert to protect weights. Wood cases for weights sized 2 kg through 1 mg are designed to hold a weight inside a polycarbonate individual case. This “case-in-a-case” feature guarantees the ultimate protection of your weight.

Visit our website at www.troemner.com for additional case dimensions.

Weight	Part #
50 kg	SWCW—0009
20 kg	SWCW—0005
10 kg	SWCW—0004
5 kg	SWCW—0003
Holds 2 kg through 500 g weights in a polycarbonate single case within wood case	SWCW—0002
Holds 200 g through 1 mg weights in a polycarbonate single case within wood case	SWCW—0001

Heavy-Duty Cases for Individual Weights

Heavy-Duty Cases are tough, lightweight, rugged, and are designed to protect weights under any shipping circumstance. The dent and shatter resistant resin is sure to keep weights safe and secure. Each case is lined in high quality ethafoam with a custom cutout for your weight. The case is manufactured with easy press and pull latches and durable soft grip handles.

Visit our website at www.troemner.com for additional case dimensions.

Weight	Part #
50 kg	SSCA—00050
20 kg	SSCA—00020
10 kg	SSCA—00010
5 kg	SSCA—00005



5 kg case shown
Dimensions: 7" L x 7" W x 9" H
(17.8 cm x 17.8 cm x 22.9 cm)



10 kg case shown
Dimensions: 11.8" L x 9.8" W x 7.7" H
(30.0 cm x 24.9 cm x 19.6 cm)



OIML Precision Weights

Troemner UltraClass Platinum, UltraClass Gold, UltraClass and Class E0*, OIML R 111 Class E1, E2, F1, and F2



General Information

Troemner OIML Precision Weights conform to the standards of the Organisation Internationale de Metrologie Legale International Recommendation 111-1 (OIML R 111). They are manufactured from the finest stainless steels available including Troemner Alloy 8 Stainless Steel which possesses closely controlled density (8.03 g/cm³), extremely low magnetic properties, good stability, and resistance to corrosion.

OIML R 111 weight specifications are designed so the specifications on surface finish, markings, construction, material density and magnetic properties become more restrictive as weight tolerances decrease in order to enable the weight to maintain its tolerance over time. The tolerances for the various classes are established in a manner that enables the weights of higher classes to calibrate weights of the next lower class. For example, Class E2 weights can be used to calibrate Class F1 weights. To learn more about available weight classes and suggested weight applications, please see the "Selecting Weight Classes" section beginning on page 15.

Suggested Markets

Suggested Markets for OIML Precision Weights include, but are not limited to, pharmaceutical, forensic and nuclear industries.

Why UltraClass?

Available exclusively from Troemner, UltraClass weights are the most precise two-piece weights available with weight tolerances that equal or exceed Class E0*, OIML R 111 E1 and E2 tolerances. Troemner UltraClass weights combine high precision with the advantage of two-piece construction (1 g and larger), avoiding costly replacement issues associated with one-piece weights. To learn more about available weight classes and suggested weight applications, please see the "Selecting Weight Classes" section beginning on page 15.

Tolerance Classes

Please see the Tolerance Chart on pages 19-20 or on our website at www.troemner.com for specific information on the tolerances of each weight of a given OIML Class.



Construction and General Shape

As specified in OIML R 111, Troemner's OIML Precision Weights are available in one or two-piece construction.

Milligram Weights - Troemner OIML Precision Weights 500 mg and below are flat weights made of stainless steel or aluminum. Weights are one-piece construction with one side turned up to make them easy to handle with forceps. Corners and edges are smooth. There are no markings permitted on any weight 500 mg and below. The nominal value of weights 500 mg and below is determined by the shape of the weight according to the following table.

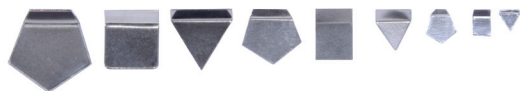

Milligram Wire Weights - Weights 500 mg and below are also available in wire construction with the same shape configuration as listed in the above table. Troemner's OIML wire weights have one end turned up to allow for easy handling with forceps. Flat milligram weights come standard when ordered. To order milligram wire weights, specify the Troemner part number followed by "-wire".



Shape	Denomination
Pentagon	500 mg, 50 mg, 5 mg
Square	200 mg, 20 mg, 2 mg
Triangle	100 mg, 10 mg, 1 mg

Gram Weights - Weights 1 g and above can be either one or two-piece construction. Troemner OIML Precision Weights 1 g and larger are cylindrical in shape with a tapered neck for easy gripping. They are perfectly flat on top to stack easily on center. Weight bottoms are slightly recessed to expose the smallest possible area to wear.

One-piece construction indicates the weight is manufactured from a single uniform piece of stainless steel, the weight has no other material added to it, and it has no method of adjustment other than removing material by polishing. Class E0*, OIML R 111 Class E1, and E2 weights 1 g and larger are of one-piece construction.

Two-piece construction indicates that the weight is constructed of two pieces of stainless steel. In the case of Troemner OIML Precision Weights, this means that the weight body is constructed of one piece of material and the lifting knob or head is constructed from a different piece of material. Although the head and body may come from different bars of material, they are the same grade and type of material with the same densities. The knob or head screws into the body and one can barely tell that the weight is not constructed of one piece of material. There is a cavity below the knob thread in the body which contains adjusting material, typically the same material from which the weight is made. OIML R 111 Class F1 and F2 and UltraClass Series weights 1 g and larger are cylindrical in shape and are of two-piece construction.

* E0 is a theoretical tolerance that is 50% of OIML R 111 Class E1

Surface Finish

All surfaces are polished to a perfect, mirror-like finish and meet or exceed OIML R 111 specifications. For OIML R 111 surface finish specifications visit www.troemner.com.

Material Specifications

The table below describes the material used in the construction of Troemner OIML Precision Weights.



Weight Range	Base Material	Density
Milligram Weights 5 mg — 500 mg	304 Stainless Steel	7.95 g/cm ³ at 20°C
Milligram Weights 1 mg — 2 mg	3003-H14 Aluminum	2.7 g/cm ³ at 20°C
Class E0*, OIML R 111 Class E1 & E2 Weights 20 kg — 50 kg	316 Stainless Steel	7.95 g/cm ³ at 20°C
Class E0*, OIML R 111 Class E1 & E2 Weights 1 g — 10 kg	Troemner Alloy 8	8.03 g/cm ³ at 20°C
Class F1 & F2 and UltraClass Series Weights 2 kg — 50 kg	316 Stainless Steel	7.95 g/cm ³ at 20°C
Class F1 & F2 and UltraClass Series Weights 1 g — 1 kg	Troemner Alloy 8	8.03 g/cm ³ at 20°C

E0*, E1 and E2 weights are one-piece weights
 UltraClass Series, Class F1 and F2 weights 1 g and larger are two-piece weights
 Milligram weights are one-piece weights

* E0 is a theoretical tolerance that is 50% of OIML R 111 Class E1



OIML Precision Weights

Weight Sets



Weight Set Configuration Information

Troemner weight sets are supplied in a 5-2-2-1 series unless a 5-3-2-1 series is specified. 5-2-2-1 means that weights beginning with a "2" are doubled in each decade and weights beginning with a "5" and "1" are single in each decade. For example, a set with 5-2-2-1 series from 50 g to 1 g includes; one 50 g, two 20 g, one 10 g, one 5 g, two 2 g, and one 1 g. A 50 g to 1 g set in a 5-3-2-1 series would contain one 50 g, one 30 g, one 20 g, one 10 g, one 5 g, one 3 g, one 2 g, and one 1 g. If a 5-3-2-1 set is required, please contact a Troemner Sales Representative at [800-249-5554](tel:800-249-5554) or troemner@troemner.com to discuss your specific needs.

NOTE: The following weight set table shows each weight set in a 5-2-2-1 series.

Large Metric Sets

Troemner weight sets where the largest weight is 1 kg and above are supplied in a handcrafted wood case. Inside the wood case there is a compartment which holds a polycarbonate case containing weights 500 g and below. 1 kg and 2 kg weights are held in their individual polycarbonate weight cases inside the felt-lined compartment. For weights 5 kg, 10 kg, and 20 kg, a felt-lined compartment for each weight exists within the wood case (50 kg weights are not supplied in a case, however a case can be purchased separately). The case also features compartments for lifters and forceps supplied with each set. Weight sets where the largest weight is 10 kg and above are supplied with a Complete Accessory Kit, which includes a microfibre cloth, nylon glove, small and wide brushes, and forceps.



Weight Set	Part #*	20 kg	10 kg	5 kg	2 kg	1 kg	500 g	200 g	100 g	50 g	20 g	10 g	5 g	2 g	1 g	500 mg	200 mg	100 mg	50 mg	20 mg	10 mg	5 mg	2 mg	1 mg
20 kg — 1 g	7406	1	1	1	2	1	1	2	1	1	2	1	1	2	1									
20 kg — 1 mg	7407	1	1	1	2	1	1	2	1	1	2	1	1	2	1	1	2	1	1	2	1	1	2	1
10 kg — 1 g	7408		1	1	2	1	1	2	1	1	2	1	1	2	1									
10 kg — 1 mg	7409		1	1	2	1	1	2	1	1	2	1	1	2	1	1	2	1	1	2	1	1	2	1
5 kg — 1 kg	7442			1	2	1																		
5 kg — 1 g	7410			1	2	1	1	2	1	1	2	1	1	2	1									
5 kg — 1 mg	7411			1	2	1	1	2	1	1	2	1	1	2	1	1	2	1	1	2	1	1	2	1
2 kg — 1 g	7412				1	1	1	2	1	1	2	1	1	2	1									
2 kg — 1 mg	7413				1	1	1	2	1	1	2	1	1	2	1	1	2	1	1	2	1	1	2	1
2 kg — 1 g	7414				2	1	1	2	1	1	2	1	1	2	1									
2 kg — 1 mg	7415				2	1	1	2	1	1	2	1	1	2	1	1	2	1	1	2	1	1	2	1
1 kg — 1 g	7416					1	1	2	1	1	2	1	1	2	1									
1 kg — 1 mg	7417					1	1	2	1	1	2	1	1	2	1	1	2	1	1	2	1	1	2	1

* For creating a complete part #, refer to page 54.

NOTE: The following weight set table shows each weight set in a 5-2-2-1 series.

Medium Metric Sets

Troemner weight sets where the largest weight is 500 g and below are supplied in attractive, durable, high quality, **patented** polycarbonate cases with a compartment for each weight within the case. There is also a compartment for a brush, forceps, and a USB Flash Drive which contains the electronic certificate. (Weight sets ordered with Traceable Certificate will not have a USB Flash Drive; a printed certificate will be sent with the weights.) The cases are designed with custom inserts and bumpers so that each weight stays securely in its compartment.



Weight Set	Part #*	500 g	200 g	100 g	50 g	20 g	10 g	5 g	2 g	1 g	500 mg	200 mg	100 mg	50 mg	20 mg	10 mg	5 mg	2 mg	1 mg	
500 g — 1 g	7418	1	2	1	1	2	1	1	2	1										
500 g — 1 mg	7419	1	2	1	1	2	1	1	2	1	1	2	1	1	2	1	1	2	1	
200 g — 1 g	7420		1	1	1	2	1	1	2	1										
200 g — 1 mg	7421		1	1	1	2	1	1	2	1	1	2	1	1	2	1	1	2	1	
200 g — 1 g	7422		2	1	1	2	1	1	2	1										
200 g — 1 mg	7423		2	1	1	2	1	1	2	1	1	2	1	1	2	1	1	2	1	
100 g — 1 g	7424			1	1	2	1	1	2	1										
100 g — 1 mg	7428			1	1	2	1	1	2	1	1	2	1	1	2	1	1	2	1	
50 g — 1 g	7429				1	2	1	1	2	1										
50 g — 1 mg	7433				1	2	1	1	2	1	1	2	1	1	2	1	1	2	1	

* For creating a complete part #, refer to page 54.

NOTE: The following weight set table shows each weight set in a 5-2-2-1 series.

Small Metric Sets

Troemner weight sets where the largest weight is 5 g and below are supplied in attractive, durable, high quality, **patented** polycarbonate cases with a compartment for each weight within the case. There are also compartments for a brush and forceps. Each Milligram Case includes an inner lid that keeps weights clean and secure when in use and during shipping.



Weight Set	Part #*	5 g	2 g	1 g	500 mg	200 mg	100 mg	50 mg	20 mg	10 mg	5 mg	2 mg	1 mg	0.5 mg	0.2 mg	0.1 mg	0.05 mg
5 g — 10 mg	7444	1	2	1	1	2	1	1	2	1							
5 g — 1 mg	7441	1	2	1	1	2	1	1	2	1	1	2	1				
500 mg — 10 mg	7443				1	2	1	1	2	1							
500 mg — 1 mg	7440				1	2	1	1	2	1	1	2	1				
0.5 mg — 0.05 mg	7439													1	2	1	1

* For creating a complete part #, refer to page 54.



OIML Precision Weights



OIML Precision Weights

Individual Weights

Metric Individual Weights

Troemner individual weights 1 mg through 10 kg are supplied in attractive, durable, high quality, **patented** polycarbonate cases with custom inserts designed specifically for the style and size of the weight. The polycarbonate cases have a locking lid and a custom bumper designed to hold the weight securely in place. Protective polypropylene cases with reinforced corners are provided for weights larger than 10 kg. Wood cases are available for individual weights 1 g and larger at an additional cost. These handcrafted cases feature a wood exterior with an interior foam insert cut specifically for the size of the weight (see page 60 for example).

Weight	Part #*
50 kg	7505
20 kg	7508
10 kg	7509
5 kg	7510
2 kg	7512
1 kg	7513
500 g	7514
200 g	7516
100 g	7517
50 g	7518
20 g	7520
10 g	7521
5 g	7522
2 g	7524
1 g	7525

* For creating a complete part #, refer to page 54.

Metric Individual Milligram Weights

Troemner Milligram Weights are available in flat or wire construction. Flat milligram weights will be shipped unless “-wire” is indicated at the end of the part number upon ordering.

Weight	Part #*	Weight	Part #*
500 mg	7526	2 mg	7436
200 mg	7528	1 mg	7537
100 mg	7529	0.5 mg	7538
50 mg	7530	0.2 mg	7539
20 mg	7532	0.1 mg	7540
10 mg	7533	0.05 mg	7541
5 mg	7534		

* For creating a complete part #, refer to page 54.





Creating Your Complete OIML Precision Weight Part Number

1. Select a Part

Select a part # from the preceding tables for each product that you wish to order.

2. Select an Available Class Designation

Select a class designation from the following table. For help selecting the correct class for your application, please review the "Selecting Weight Classes" section beginning on page 15.

Troemner Available Classes	Code	OIML R 111 Available Classes	Code
UltraClass Platinum	UCP	Class E1	E1
UltraClass Gold	UCG	Class E2	E2
UltraClass	UC	Class F1	F1
Class E0*	E0*	Class F2	F2

3. Select a Certificate Code (optional)

Select a certificate code from the following table. To learn more about Troemner's certificates, please review the "Certificate Options" section beginning on page 23.

Available Certificates	Code
NVLAP+ Accredited Mass Code Report of Mass Values	MC
NVLAP+ Accredited Primary Reference Certificate	PR
NVLAP+ Accredited Certificate	W
NVLAP+ Accredited Density Determination Calibration Certificate	WDC-1111+++
NVLAP+ Accredited Magnetic Susceptibility Determination Calibration Certificate	MAGCAL-1111+++

+++ Reference part number on order as a separate line item

4. Create Your Complete Part Number(s)

Specify the Part Number + Class Code + Certificate Code (optional) for each product that you wish to order.



* E0 is a theoretical tolerance that is 50% of OIML R 111 Class E1
 * NVLAP Laboratory Code 105013-0



OIML Precision Weights

Weight Cases

Weight Cases

Troemner can provide you with the weight cases you need for proper handling and protection of your OIML Precision Weights and Weight Sets. Please contact a Troemner Sales Representative at 800-249-5554 or troemner@troemner.com for specific information on new cases, replacement cases, or special cases you need to store and protect your weights.

Polycarbonate Cases for Weight Sets

Case holds Weight Sets 500 g and below

Troemner's new **patented** Weight Set Case is constructed of high quality polycarbonate. The case is designed for OIML Precision Weight Sets where the largest weight is 500 g or below with "5-2-2-1" configuration. Case includes an inner lid over the milligram weights that keeps weights clean and secure when in use and during shipping. This case only holds metric weights. Avoirdupois weights or any other style of weights are supplied in a custom case.

Weight	Part #
500 g — 1 mg	WSCO—5001



Dimensions: 8" L x 7" W x 3.5" H
(20.32cm x 17.78cm x 8.89cm)

Polycarbonate Cases for Weight Sets

Case holds Weight Sets 5 g and below

Troemner Weight Sets where the largest weight is 5 g and below are supplied in attractive, durable, high quality, **patented** polycarbonate weight cases. Each case includes a compartment for each weight within the case. Case includes an inner lid that keeps weights clean and secure when in use and during shipping. There are also compartments for the forceps and brush (**not included**).

For our complete line of Weight Accessories, please see pages 129-136 or visit our website at www.troemner.com.

Weight	Part #
5 g — 1 mg	WSCO—0050
500 mg — 1 mg	WSCO—0005



Dimensions: 3.5" Dia. x 4.5" H
(8.9cm x 11.4cm)

Wood Cases for Weight Sets

Troemner's Wood Weight Set Cases are manufactured from oak. They hold weight sets where the largest weight is 1 kg or above. Inside the wood case there is a compartment holding a polycarbonate case containing weights 500 g and below. 1 kg and 2 kg weights are held in their individual polycarbonate weight cases inside the felt-lined compartment. For weights 5 kg, 10 kg, and 20 kg, a felt-lined compartment for each weight exists within the wood case (50 kg weights are not supplied in a case, however, a case can be purchased separately).

Weight	Part #
20 kg — 1 mg	WSWO—0001
10 kg — 1 mg	WSWO—0002
5 kg — 1 mg	WSWO—0003
2 kg — 1 mg	WSWO—0004
200 g — 1 mg	WSWO—0005



2 kg and below case shown
Dimensions: 15" L x 10" W x 7.5" H
(38.1cm x 25.4cm x 19.5cm)

Heavy-Duty Cases for Weight Sets

Heavy-Duty Cases are tough, lightweight, rugged and designed to protect your weight set under any shipping circumstance. The dent and shatter resistant resin ensures weights are kept safe and secure. Each case is lined in high quality ethafoam with custom cutouts for weights and cases. The case is manufactured with easy press and pull latches and durable soft grip handles.

Weight	Part #
20 kg — 1 mg	SSCO—20000*
10 kg — 1 mg	SSCO—10000
5 kg — 1 mg	SSCO—05000
(2) 2 kg — 1 mg	SSCO—02200
2 kg — 1 mg	SSCO—02000
1 kg — 1 mg	SSCO—01000
500 g — 1 mg	SSCO—00500

* Weight case includes wheels and a telescoping handle



500 g to 1 mg case shown
Dimensions: 13" L x 9.2" W x 6" H
(33.0cm x 23.4cm x 15.2cm)

Visit our website at www.troemner.com for additional case dimensions.

Aluminum Cases for Weight Sets

Aluminum Cases are strong, lightweight, and extremely durable. Each case is lined in high quality ethafoam with custom cutouts for weights or cases. Cases are designed with positive locking latches and each case is equipped with a triple digit combination lock.

Visit our website at www.troemner.com for additional case dimensions.

Weight	Part #
10 kg — 1 mg	ASCO—10000
5 kg — 1 mg	ASCO—05000
(2) 2 kg — 1 mg	ASCO—02200
2 kg — 1 mg	ASCO—02000
1 kg — 1 mg	ASCO—01000
500 g — 1 mg	ASCO—00500



2 kg through 1 mg case shown
Dimensions: 18" L x 14" W x 5.5" H
(40.6cm x 22.9cm x 20.3cm)

Polycarbonate Cases for Individual Weights

Case holds weights 10 kg and 5 kg

Troemner's Kilogram Cases are designed to securely hold, protect, and transport your weights sized 10 kg and 5 kg. Each case has a comfortable carrying handle, a recessed grip for removing the lid, side latches for securing the lid in place, and a color-coded insert. Urethane bumpers, both inside the lid and on the bottom of the case, gently hold the weight in place.

Weight	Part #
10 kg	SWCO—10000
5 kg	SWCO—5000



Dimensions: 6" Dia. x 10.25" H
(15.2cm x 26.0cm)

Polycarbonate Cases for Individual Weights

Case holds weights 2 kg through 1 g

Troemner's **patented** individual Polycarbonate Cases are designed to securely hold and protect your weights sized 2 kg through 1 g. As the lid is rotated open, the color-coded insert and weight move with the lid. This prevents the urethane bumper from rubbing on the weight, further protecting your weight's calibration.

Weight	Part #
2 kg	SWCO—2000
1 kg	SWCO—1000
500 g	SWCO—0500
200 g	SWCO—0200
100 g	SWCO—0100
50 g	SWCO—0050
30 g	SWCO—0030
20 g	SWCO—0020
10 g	SWCO—0010
5 g	SWCO—0005
3 g	SWCO—0003
2 g	SWCO—0002
1 g	SWCO—0001



Large size holds 2 kg through 500 g
Dimensions: 3.5" Dia. x 4.5" H
(8.9cm x 11.4cm)



Small size holds 200 g through 1 g
Dimensions: 2" Dia. x 2.5" H
(5.1cm x 6.4cm)

Polycarbonate Cases for Individual Weights

Case holds weights 500 mg through 1 mg

Troemner's **patented** Milligram Cases hold up to seven sheet metal or wire weights sized 500 mg through 1 mg. Each Milligram Case includes an inner lid that keeps weights clean and secure when in use and during shipping.

Weight	Part #
Up to (7) mg weights	SWCO—0000



Assembled dimensions: 2" Dia. x 2.5" H
(5.1cm x 6.4cm)

Polypropylene Cases for Individual Weights

Troemner's Polypropylene Individual Weight Cases are made of high impact plastic. Cases are made with reinforced metal edges and corners. They also have a padded carrying handle to ensure proper handling during transport.

Visit our website at www.troemner.com for additional case dimensions.

Weight	Part #
50 kg	TWO—100—50KG
20 kg	TWO—100—20KG



25 kg case shown
Dimensions: 8" L x 8" W x 9" H
(20.3cm x 20.3cm x 22.9cm)

Wood Cases for Individual Weights

Individual Wood Cases are made of oak construction with a foam insert to protect weights. Wood Cases for weights sized 2 kg through 1 mg are designed to hold a weight inside a polycarbonate individual case. This "case-in-a-case" feature guarantees the ultimate protection of your weight.

Visit our website at www.troemner.com for additional case dimensions.

Weight	Part #
50 kg	SWCW—0010
20 kg	SWCW—0006
10 kg	SWCW—0007
5 kg	SWCW—0008
Holds 2 kg to 500 g weights in a polycarbonate single case within wood case	SWCW—0002
Holds 200 g to 1 mg weights in a polycarbonate single case within wood case	SWCW—0001



5 kg case shown
Dimensions: 7" L x 7" W x 9" H
(17.8cm x 17.8cm x 22.9cm)

Heavy-Duty Cases for Individual Weights

Heavy-Duty Cases are tough, lightweight, rugged and are designed to protect your weights under any shipping circumstance. The dent and shatter resistant resin is sure to keep weights safe and secure. Each case is lined in high quality ethafoam with a custom cutout for your weight. The case is manufactured with easy press and pull latches and durable soft grip handles.

Visit our website at www.troemner.com for additional case dimensions.

Weight	Part #
50 kg	SSCO—00050
20 kg	SSCO—00020
10 kg	SSCO—00010
5 kg	SSCO—00005



10 kg case shown
Dimensions: 11.8" L x 9.8" W x 7.7" H
(30.0cm x 24.9cm x 19.6cm)



Cal-Paks™

Troemner UltraClass, ANSI/ASTM E617 Class 1 and
OIML R 111 Class E2 and F1



General Information

Troemner Cal-Paks™ contain (3) high quality, precision weights which can be used with all balance manufacturers' makes and models. The weights supplied are the balance manufacturers' recommended calibration weight, 10% of the calibration weight, and the minimum weight as determined by the balance's readability and expected standard deviation under normal conditions as recommended by USP 41 (United States Pharmacopeia).

Troemner Cal-Pak™ components and carrying case are linked through the use of a unique serial number. You can trace your individual weights to the appropriate NVLAP+ Accredited Certificate and master carrying case. The precision weights in your Cal-Pak™ are traceable to internationally recognized standards through an exacting series of precision measurements that provide an accurate value for each weight with low uncertainty. Troemner's NVLAP+ Accredited Certificate provides evidence that the process for the measurement traceability chain meets the stringent requirements of ISO/IEC 17025 and has been approved by NVLAP+.

Calibration Consistency - Troemner addresses every variable of our measurement process to ensure consistency of calibration results for your processes, products and services.

Alloy 8 Advantage - Troemner Alloy 8 Stainless Steel is the finest grade of stainless steel available. Alloy 8 possesses closely controlled density (8.03 g/cm³), extremely low magnetic properties, good stability, and resistance to corrosion. Alloy 8 is available exclusively through Troemner.

Lowest Uncertainties - Troemner is committed to achieving the highest measurement capabilities and offering the lowest measurement uncertainties possible. The true test of how well we perform a calibration is in the reported uncertainty, which

provides you a higher level of confidence.

Electronic Certificates

Your Cal-Pak™ includes a USB Flash Drive that contains your electronic NVLAP+ Accredited Certificate. The USB Flash Drive provides you with a paperless system for your certificates to be easily accessed and maintained over time. Return your flash drive each time you have your Cal-Pak™ recalibrated and we will add the new NVLAP+ Accredited Certificate to the flash drive. This green system provides you with a history of your weights all in one convenient place with no paper to keep on file. All the information is maintained on the Flash Drive so you can print the NVLAP+ Accredited Certificate when necessary.

Suggested Applications

Cal-Paks™ are used for routine maintenance of your balance. Troemner provides you with (3) weights that will allow you to cover the entire usable range of your balance. The maximum weight is used to calibrate the balance externally, the mid weight is 10% of the calibration weight to test the sensitivity of the balance, and the minimum weight is the lowest possible weight that can be weighed on your balance. The minimum weight was selected based on USP 41 test for minimum weight and the expected standard deviation of your balance at the minimum weight. The three weights will test the accuracy and linearity of your balance throughout its entire range.

Tolerance Classes

Refer to Troemner's Tolerance Chart on pages 19-21 for specific information on the tolerance of each weight in a given class. Troemner's Tolerance Chart is also available on www.troemner.com for additional reference.

Construction and General Shape

Troemner Cal-Paks™ are available in either Analytical Precision Weight or OIML Precision Weight styles. Each style differs in construction and shape as described below.

Milligram Weights - Both Analytical Precision Weights and OIML Precision Weights 500 mg and below are made of stainless steel or aluminum and are one-piece construction with one side turned up to make them easier to handle with forceps. Analytical Precision milligram weights are rectangular and all classes are marked with their nominal value. Each OIML Precision milligram weight's nominal value is determined by the shape of the weight according to the table below.

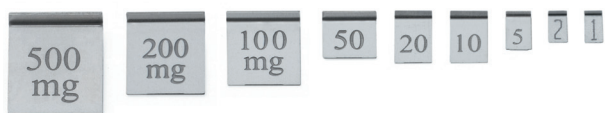

ANSI/ASTM E617 Milligram Weights

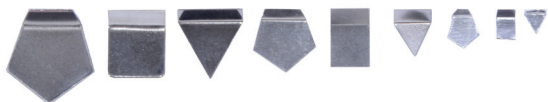

OIML R 111 Milligram Weights

Shape	Denomination
Pentagon	500 mg, 50 mg, 5 mg
Square	200 mg, 20 mg, 2 mg
Triangle	100 mg, 10 mg, 1 mg

Gram Weights - Analytical Precision Weights and OIML Precision Weights 1 g and larger consist of a body with a lifting knob. The lifting knob is specifically designed for use with forceps or some other lifting device. Weight bottoms are slightly recessed to expose the smallest possible area to wear. Each weight (except OIML R111 Class E2) is marked with its nominal value.

OIML R 111 class E2 weights 1 g and larger are of one-piece construction using Troemner Alloy 8 Stainless Steel which has a consistent density. One-piece construction indicates that the weight is manufactured from a single uniform piece of stainless steel or aluminum, the weight has no method of adjustment other than removing material by polishing.

All other weights 1 g and larger are produced from two pieces of material. The body of the weight is one piece and the knob is the second piece. The knob has a thread that screws into the body and is tightened. There is a cavity below the knob thread in the body which contains adjusting material, typically the same material from which the weight is made.



ANSI/ASTM E617 Gram Weight



OIML R 111 Gram Weight

Material Specifications

The table below describes the material used in the construction of Troemner ANSI/ASTM E617 and OIML R 111 Precision Weights.

Troemner UltraClass and ANSI/ASTM E617 Class 1

Weight Range	Base Material	Density
2 kg — 5 kg	316 Stainless Steel	7.95 g/cm ³ at 20° C
1 g — 1 kg	Troemner Alloy 8	8.03 g/cm ³ at 20° C
5 mg — 500 mg	304 Stainless Steel	7.95 g/cm ³ at 20° C
1 mg — 3 mg	3003-H14 Aluminum	2.7 g/cm ³ at 20° C

Weights 1 g and larger are two-piece weights.
Milligram weights are one-piece weights.

OIML R 111 Class E2 and F1

Weight Range	Base Material	Density
Class E2 One-Piece Weights 1 g and larger	Troemner Alloy 8	8.0 g/cm ³ at 20° C
Class F1 Two-Piece Weights 2 kg — 5 kg	316 Stainless Steel	7.95 g/cm ³ at 20° C
Class F1 Two-Piece Weights 1 g — 1 kg	Troemner Alloy 8	8.0 g/cm ³ at 20° C
Sheet Metal Weights 5 mg — 500 mg	316 Stainless Steel	7.95 g/cm ³ at 20° C
Sheet Metal Weights 1 mg — 2 mg	3003-H14 Aluminum	2.7 g/cm ³ at 20° C

Milligram weights are one-piece weights.

Surface Finish

All surfaces are to be finished to a perfect mirror like finish and conform to specifications in ANSI/ASTM E617 or OIML R 111. Surface finish specifications are available on www.troemner.com for additional reference.



Cal-Paks™

Troemner UltraClass and ANSI/ASTM E617 Class 1

Large Cal-Paks™

Troemner Cal-Paks™ where the largest weight is above 200 g are supplied in a rugged polypropylene case with each individual weight in its own high quality polycarbonate case (5 kg weights are set inside a foam insert within the master case). Accessories for proper care and handling of weights are also included.



Class 1 with NVLAP+ Accredited Certificate

Weight Set	Part #	5 kg	2 kg	1 kg	500 g	200 g	100 g	50 g	20 g	10 g	5 g	2 g	1 g	500 mg	200 mg	100 mg	50 mg	20 mg
5 kg — 20 g	7267-1W	1			1				1									
5 kg — 20 g*	7267-1GW	1			1				1									
5 kg — 20 g	7269-1W	1				1			1									
5 kg — 20 g*	7269-1GW	1				1			1									
5 kg — 2 g	7266-1W	1			1							1						
5 kg — 2 g*	7266-1GW	1			1							1						
5 kg — 2 g	7268-1W	1				1						1						
5 kg — 2 g*	7268-1GW	1				1						1						
2 kg — 20 g	7265-1W		1			1			1									
2 kg — 2 g	7264-1W		1			1						1						
1 kg — 20 g	7263-1W			1			1		1									
1 kg — 2 g	7262-1W			1			1					1						
500 g — 2 g	7261-1W				1			1				1						
500 g — 200 mg	7260-1W				1			1							1			

*5 kg is a grip handle weight

Small Cal-Paks™

Troemner Cal-Paks™ where the largest weight is 200 g and below are supplied in an attractive, durable, high quality, **patented** polycarbonate case with each individual weight in its own polycarbonate case. Accessories for proper care and handling of weights are also included.



Class 1 with NVLAP+ Accredited Certificate

Weight Set	Part #	200 g	100 g	50 g	20 g	10 g	5 g	2 g	1 g	500 mg	200 mg	100 mg	50 mg	20 mg	10 mg	5 mg	2 mg	1 mg
200 g — 2 g	7258-1W	1			1			1										
200 g — 200 mg	7257-1W	1			1			1			1							
100 g — 2 g	7256-1W		1			1		1										
100 g — 200 mg	7255-1W		1			1					1							
100 g — 20 mg	7254-1W		1			1								1				
50 g — 2 g	7253-1W			1			1	1										
50 g — 200 mg	7252-1W			1			1				1							
20 g — 200 mg	7271-1W				1			1			1							
20 g — 20 mg	7270-1W				1			1						1				

UltraClass with NVLAP+ Accredited Certificate

Weight Set	Part #	200 g	100 g	50 g	20 g	10 g	5 g	2 g	1 g	500 mg	200 mg	100 mg	50 mg	20 mg	10 mg	5 mg	2 mg	1 mg
5 g — 1 mg	7251-00W						1			1								1
2 g — 1mg	7250-00W							1			1							1



Cal-Paks™

OIML R 111 Class E2 and F1

Large Cal-Paks™

Troemner Cal-Paks™ where the largest weight is above 200 g are supplied in a rugged polypropylene case with each individual weight in its own high quality polycarbonate case (5 kg weights are set inside a foam insert within the master case). Accessories for proper care and handling of weights are also included.



Class F1 with NVLAP+ Accredited Certificate

Weight Set	Part #	5 kg	2 kg	1 kg	500 g	200 g	100 g	50 g	20 g	10 g	5 g	2 g	1 g	500 mg	200 mg	100 mg	50 mg	20 mg
5 kg — 20 g	7467-F1NA	1			1				1									
5 kg — 20 g	7469-F1NA	1				1			1									
5 kg — 2 g	7466-F1NA	1			1							1						
5 kg — 2 g	7468-F1NA	1				1						1						
2 kg — 20 g	7465-F1NA		1			1			1									
2 kg — 2 g	7464-F1NA		1			1						1						
1 kg — 20 g	7463-F1NA			1			1		1									
1 kg — 2 g	7462-F1NA			1			1					1						
500 g — 2 g	7461-F1NA				1			1				1						
500 g — 200 mg	7460-F1NA				1			1							1			
500 g — 20 mg	7459-F1NA				1			1										1

Small Cal-Paks™

Troemner Cal-Paks™ where the largest weight is 200 g and below are supplied in an attractive, durable, high quality, **patented** polycarbonate case with each individual weight in its own polycarbonate case. Accessories for proper care and handling of weights are also included.



Class F1 with NVLAP+ Accredited Certificate

Weight Set	Part #	200 g	100 g	50 g	20 g	10 g	5 g	2 g	1 g	500 mg	200 mg	100 mg	50 mg	20 mg	10 mg	5 mg	2 mg	1 mg	
200 g — 2 g	7458-F1NA	1			1			1											
200 g — 200 mg	7457-F1NA	1			1						1								
100 g — 2 g	7456-F1NA		1			1		1											
100 g — 200 mg	7455-F1NA		1			1					1								
100 g — 20 mg	7454-F1NA		1			1								1					
50 g — 2 g	7453-F1NA			1			1	1											
50 g — 200 mg	7452-F1NA			1			1				1								
5 g — 1 mg	7451-F1NA						1			1									1
2 g — 1 mg	7450-F1NA							1			1								1

Class E2 with NVLAP+ Accredited Certificate

Weight Set	Part #	200 g	100 g	50 g	20 g	10 g	5 g	2 g	1 g	500 mg	200 mg	100 mg	50 mg	20 mg	10 mg	5 mg	2 mg	1 mg	
5 g — 1 mg	7451-E2NA						1			1									1
2 g — 1 mg	7450-E2NA							1			1								1



Electronic Balance Weights

Troemner UltraClass and ANSI/ASTM E617 Class 1, 2, 3, and 4



General Information

To get all the accuracy your electronic balance and/or scale provides, you need to perform routine calibrations and verifications using precision calibration weights. Troemner's Electronic Balance Weights are intended for this purpose and are available in Troemner UltraClass and ANSI/ASTM E617 Class 1, 2, 3, and 4 in sizes ranging from 10 g through 30 kg.

Weights are available in a cylindrical design up through 5 kg and a stackable grip-handle design from 5 kg through 30 kg for all necessary testing, calibration and adjustment of electronic scales and balances. All ANSI/ASTM E617 class weights meet or exceed specifications for tolerance, construction, surface finish, and magnetism as outlined in ANSI/ASTM E617. Weights 5 kg and below are supplied in protective cases. Cases for weights 10 kg and above are available at an additional cost.

Electronic Balance Weights can be used to check or verify the accuracy of your balance and/or scale between calibrations. It is recommended that the user check a balance and/or scale prior to each use. Keeping the weight at or near the balance and/or scale keeps the weight at the same temperature as the equipment.

Suggested Markets

Electronic Balance Weights are ideal for non chemical environments to verify balances or scales.

Why UltraClass?

Available exclusively from Troemner, UltraClass weights are the most precise two-piece weights available with weight tolerances that equal or exceed ANSI/ASTM E617 Class 0 tolerances. Troemner UltraClass weights combine high precision with the advantage of two-piece construction avoiding costly replacement issues associated with one-piece weights. To learn more about available weight classes and suggested weight applications, please see the "Selecting Weight Classes" section beginning on page 15.

Tolerance Classes

Stainless Steel Electronic Balance Weights are adjusted to Troemner UltraClass and ANSI/ASTM E617 Class 1, 2, 3, and 4.

It is recommended that the weight selected to calibrate a balance and/or scale have a tolerance small enough not to be detected by the balance and/or scale. Troemner recommends the tolerance of a weight selected for calibrating a balance and/or scale is no more than 1/3 of the readability or precision of the balance and/or scale being calibrated. If this cannot be achieved, it is suggested that a Class 0 or Troemner UltraClass Electronic Balance Weight with a NVLAP⁺ Certificate be ordered which provides the actual mass value for the weight which reduces measurement uncertainty.

Refer to Troemner's Tolerance Chart on pages 19-20 for specific information on the tolerance of each weight in a given class. Troemner's Tolerance Chart is also available on www.troemner.com for additional reference.

Construction and General Shape

Troemner's Electronic Balance Weights are manufactured from a high quality stainless steel alloy, possessing closely controlled density, low magnetic susceptibility, good stability, and resistance to corrosion. All of Troemner's Electronic Balance Weights are made of two pieces and have a cavity that allows for adjustment during future calibrations. Within the cavity there is adjusting material, typically the same material from which the weight is made. This cavity is sealed during the production process to ensure the stability of the weight. Electronic Balance Weights are cylindrical in shape and flat on top to stack easy on center.

Straight Cylinder Weights - Weights from 10 g through 600 g are machined as straight cylinders with the adjusting cavity opening in the bottom of the weight.

Cylindrical Weights - Cylindrical weights from 1 kg to 5 kg are machined as cylinders and have a groove around the diameter approximately 25% from the top of the weight to allow for easier handling. The adjusting cavity opening is in the bottom of the weight.

Grip Handle Weights - Grip handle weights from 4 kg through 30 kg have a recess in the top center of the weight with a lifting handle spanning the recess slightly below the top surface of the weight. The recess allows the user to pick up the weight using the handle and provides clearance for the user's hand. Grip handle weights 4 kg to 10 kg are 5 inches in diameter. Grip handle weights above 10 kg through 30 kg are 6 inches in diameter. The adjusting cavity for grip handle weights is within the lifting handle.

Surface Finish

Troemner UltraClass as well as ANSI/ASTM Class 1, 2, and 3 weights all have surfaces polished to a perfect, mirror-like finish. ANSI/ASTM Class 4 weights have a satin-like appearance and finish. All surface finishes meet or exceed ANSI/ASTM E617 specifications. Surface finish for Troemner UltraClass meets or exceeds ANSI/ASTM E617 Class 0 specifications. Surface finish specifications are available on www.troemner.com for additional reference.



Material Specifications for Troemner UltraClass and ANSI/ASTM E617 Class 1, 2, 3 and 4

Weight Range	Base Material	Density
2 kg — 30 kg	303 Stainless Steel	7.85 g/cm ³ at 20° C
10 g — 1500 g	316 Stainless Steel	7.95 g/cm ³ at 20° C

Troemner Electronic Balance Weights are also available in Avoirdupois denominations. Please contact a Troemner Sales Representative at 800-249-5554 or troemner@troemner.com or more information.

Electronic Balance Metric Weight Set

One weight set is available in Electronic Balance Weight design. The set consists of one 1 kg, one 500 g, one 300 g, one 200 g, and one 100 g. The set is supplied in a rugged polypropylene case with a handle on top and a nylon glove. The set is pictured in the group image below.

Weight Set	Part #**	1 kg	500 g	300 g	200 g	100 g
100 g — 1 kg	8*70	1	1	1	1	1

* Replace the asterisk (*) with the desired class code to complete the part # used to order.
 ** For creating a complete part #, refer to page 74.



Electronic Balance Weights



Electronic Balance Weights

Individual Weights



Metric Individual Weights

To safeguard your Electronic Balance Weights, attractive, durable, high quality, polycarbonate cases are provided with weights 10 g through 5 kg. The polycarbonate cases feature a custom insert, bumper, and locking lid to assure weights are held securely within the case and avoid movement. A nylon glove is provided with each weight. Polycarbonate cases for 10 kg weights are available at an additional cost.

Polypropylene cases with handles for larger Electronic Balance Weights 16 kg through 30 kg are available at an additional cost. These cases are made of high-impact plastic, reinforced with metal edges and corners and have a padded carrying handle. Please contact a Troemner Sales Representative at [800-249-5554](tel:800-249-5554) or troemner@troemner.com for more information.

Grip Handle Weights

Weight	Part #**
30 kg	8*00
25 kg	8*02
24 kg	8*04
20 kg	8*06
16 kg	8*08
10 kg	8*10
8 kg	8*12
5 kg	8*14
4 kg	8*18

Cylindrical Weights with Groove

Weight	Part #**
5 kg	8*16
4 kg	8*20
3 kg	8*22
2 kg	8*24
1500 g	8*26
1000 g	8*28

Straight Cylindrical Weights

Weight	Part #**
600 g	8*30
500 g	8*32
400 g	8*34
300 g	8*36
200 g	8*38
160 g	8*40
150 g	8*42
100 g	8*44
80 g	8*46
70 g	8*48
60 g	8*50
50 g	8*52
40 g	8*53
30 g	8*54
20 g	8*56
10 g	8*58

* Replace the asterisk (*) with the desired class code to complete the part # used to order.

** For creating a complete part #, refer to page 74.



Creating Your Complete Electronic Balance Weight Part Number

1. Select a Part

Select a part # from the preceding tables for each product that you wish to order.

2. Select an Available Class Designation

Select a class designation from the following table and, for ANSI/ASTM E617 classes and UltraClass, place it as the second digit within the part number, replacing the asterisk (*). For help selecting the correct class for your application, please review the "Selecting Weight Classes" section beginning on page 15.

Troemner Classes	Code	ANSI/ASTM E617 Classes	Code
UltraClass	0	Class 3	3
Class 1	1	Class 4	4
Class 2	2		

3. Select a Certificate Code (optional)

Select a certificate code from the following table. To learn more about Troemner's certificates, please review the "Certificate Options" section beginning on page 23.

Available Certificates	Code
NVLAP+ Accredited Certificate	W
Traceable Certificate	T

4. Create Your Complete Part Number(s)

Specify the Part Number + Class Code + Certificate Code (optional) for each product that you wish to order.

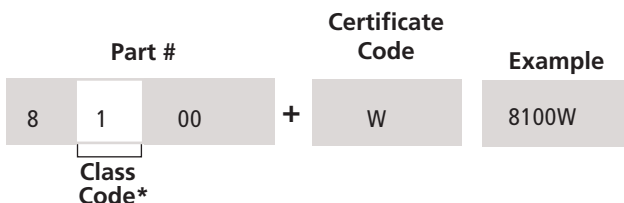

* NVLAP Laboratory Code 105013-0



Electronic Balance Weights Weight Cases

Troemner can provide you with the weight cases you need to properly handle and protect your Electronic Balance Weights. A case and nylon glove are included for weights 10 g through 5 kg. Cases for larger weights are available at an additional cost. Please contact a Troemner Sales Representative at [800-249-5554](tel:800-249-5554) or troemner@troemner.com to discuss your specific needs for storing and protecting your Electronic Balance Weights.

Polycarbonate Cases for Individual Weights

Case holds weights 10 kg, 8 kg, 5 kg and 4 kg

Troemner's Kilogram Cases are designed to securely hold, protect, and transport your weights sized 10 kg, 8 kg, 5 kg and 4 kg. Each case has a comfortable carrying handle, side latches for holding the lid in place, and a color-coded insert. Case also features urethane bumpers that gently hold weights in place.

Weight Case	Part #
10 kg Grip	SWCE—10000
8 kg Grip	SWCE—8000
5 kg Cylindrical	SWCE—5000
5 kg Grip	SWCE—5000G
4 kg Grip	SWCE—4000G



Dimensions: 6" Dia. x 10.25" H
(15.2 cm x 26.0 cm)

Polycarbonate Cases for Individual Weights

Case holds weights 2 kg through 10 g

Troemner's **patented** Individual Polycarbonate Cases are designed to securely hold and protect your weights sized 2 kg through 10 g. As the lid is rotated open, the color-coded insert and weight move with the lid. This prevents the urethane bumper from rubbing on the weight, further protecting your weight's calibration.

Weight	Part #
2 kg	SWCE—2000
1500 g	SWCE—1500
1000 g	SWCE—1000
600 g	SWCE—0600
500 g	SWCE—0500
400 g	SWCE—0400
300 g	SWCE—0300
200 g	SWCE—0200
160 g	SWCE—0160
150 g	SWCE—0150
100 g	SWCE—0100
80 g	SWCE—0080
70 g	SWCE—0070
60 g	SWCE—0060
50 g	SWCE—0050
40 g	SWCE—0040
30 g	SWCE—0030
20 g	SWCE—0020
10 g	SWCE—0010



Large size holds 2 kg to 300 g
Dimensions: 3.5" Dia. x 4.5" H
(8.9 cm x 11.4 cm)

Small size holds 200 g to 1 g
Dimensions: 2" Dia. x 2.5" H
(5.1 cm x 6.4 cm)

Polypropylene Cases for Individual Weights

Troemner's Polypropylene Individual Weight Cases are made of high impact plastic. Cases are made with reinforced metal edges and corners. They also have a padded carrying handle to ensure proper handling during transport.

Visit our website at www.troemner.com for additional case dimensions.

Weight Case	Part #
30 kg Grip	TW—100—30KG
25 kg Grip	TW—100—25KG
20 kg Grip	TW—100—20KG
16 kg Grip	TW—100—20KG



25 kg case shown
Dimensions: 8" L x 8" W x 9" H
(20.3 cm x 20.3 cm x 22.9 cm)

Heavy-Duty Cases for Individual Weights

Heavy-Duty Cases are tough, lightweight, rugged, and are designed to protect weights under any shipping circumstance. The dent and shatter resistant resin is sure to keep weights safe and secure. Each case is lined in high quality ethafoam with a custom cutout for your weight. The case is manufactured with easy press and pull latches and durable soft grip handles.

Visit our website at www.troemner.com for additional case dimensions.

Weight	Part #
20 kg Grip	SSCE—00020
10 kg Grip	SSCE—00010
5 kg Grip	SSCE—00005
5 kg Cylindrical	SSCE—00005C
4 kg Grip	SSCE—00004



10 kg case shown
Dimensions: 11.8" L x 9.8" W x 7.7" H
(30.0 cm x 24.9 cm x 19.6 cm)



Troemner 1 kg Primary Alloy 8 Mass Standard Weight

Troemner's 1 kg Primary Standard is a cylindrical weight made from Troemner Alloy 8 Stainless Steel calibrated to meet Class E0*, OIML R 111 Class E1 or ANSI/ASTM E617 Class 000 or 00. Troemner's best measurement uncertainty is available with these weights. All weights include a NVLAP+ Accredited Certificate, NVLAP+ Accredited Density Determination Certificate and NVLAP+ Accredited Magnetic Susceptibility Determination Certificate. All weights are supplied in high quality cases. To order please contact a Troemner Sales Representative at [800-249-5554](tel:800-249-5554) or troemner@troemner.com to discuss your specific needs.

Primary Standards recommended applications vary by class as follows:

ANSI/ASTM E617 Class 000 or Class E0* - Used as a national standard. Class 000 and E0* are also used for calibration of the mass standards of class OIML R 111 Class E1.

ANSI/ASTM E617 Class 00 or OIML R 111 Class E1 - Used for adjustment, testing, official calibration, and instrument calibration for the quality assurance of balances with more than 1,000,000 steps in accordance with DIN EN ISO 9001ff. These classes are also used for the official calibration of weights of

class E2 in accordance with OIML R 111, and for high precision weighing or comparative measurements on measurement comparators.

Troemner's one-piece, 1 kg Primary Standard Weights are used primarily by calibration laboratories as a reference standard in performing precision calibrations by dissemination. The advantage of this weight is the high polish that exceeds the standards as required by ANSI/ASTM E617 Class 000. Low magnetic susceptibility and durability provides for a stable mass value over time. The weight is machined on the bottom for minimal contact on the weight pan. The density is always determined with an uncertainty of 0.0013g/cm³ to minimize the effect on the uncertainty of the measurement.



1 kg Primary Standard

Weight	ANSI/ASTM Class 000 Part #	ANSI/ASTM Class 00 Part #	Class E0* Part #	OIML R 111 Class E1 Part #
1 kg Troemner Alloy 8 Stainless Steel	1001	1002	1003	1004

* NVLAP Laboratory Code 105013-0

* E0 is a theoretical tolerance that is 50% of OIML R 111 Class E1



Stainless Steel Heavy Capacity Weights

ANSI/ASTM E67 Class **2, 3, 4, 5, 6** and
NIST Class F 105-1



General Information

Troemner's Stainless Steel Heavy Capacity Weights are an ideal solution for the food, beverage, pharmaceutical, nuclear, and fine chemical industries. Manufactured from stainless steel, these weights are highly stable and resistant to corrosion – ideal for wash down environments and as a replacement for your cast iron weights. Troemner's Stainless Steel Heavy Capacity Weights can be supplied with Troemner's NIST Traceable Certificate up to 2000 kg (5000 lb) or with a NVLAP+ Accredited Certificate for weights up to 1000 kg (3000 lb).

Suggested Markets

Suggested Markets for Stainless Steel Heavy Capacity Weights include, but are not limited to, food, beverage, pharmaceutical, nuclear, and fine chemical industries. Stainless Steel Heavy Capacity Weights are also used to test commercial weighing devices by state and local weights and measures officials, device installers, and service technicians.

Tolerance Classes

Stainless Steel Heavy Capacity Weights are adjusted to ANSI/ASTM E617 Class 2, 3, 4, 5, and 6, and NIST Class F. Refer to Troemner's Tolerance Chart on pages 19-20 for specific information on the tolerance of each weight in a given class. Troemner's Tolerance Chart is also available on www.troemner.com for additional reference.

Surface Finish

All surfaces have a satin finish and are smooth and free of scratches as outlined in ANSI/ASTM E617. Surface finish specifications are available on www.troemner.com for additional reference.

Material Specifications

Weight Range	Base Material	Density
All Sizes	303-304 Stainless Steel	7.85 g/cm ³ at 20° C

Construction and General Shape

Troemner's Stainless Steel Heavy Capacity Weights are manufactured from a stainless steel alloy which possesses closely controlled density, low magnetic susceptibility, good stability and resistance to corrosion. Weights range from 20 kg/75 lb and up, are cylindrical in shape and have a secure eyebolt on the top center of the weight to allow them to be moved easily with various types of industrial equipment.

All of Troemner's Stainless Steel Heavy Capacity Weights have two-piece construction that allows the weights to be adjusted. Within each weight there is a cavity below the eyebolt that is filled with adjusting material, typically the same material from which the weight is made. This cavity is sealed during the production process to ensure the stability of the weight.

The eyebolt has an opening of 1½ inches. Custom Stainless Steel Heavy Capacity Weights of any nominal value from 20 kg/75 lb up to 2000 kg/5000 lb can be manufactured to meet your specific requirements. Please contact a Troemner Sales Representative at 800-249-5554 or troemner@troemner.com to discuss your specific needs.



Stainless Steel Heavy Capacity Weights

Individual Weights

Stainless Steel Heavy Capacity Weights are not supplied in cases. Troemner manufactures a variety of custom containers and carts to properly store and transport your Stainless Steel Heavy Capacity Weights and keep them clean and protected. Containers and carts can be manufactured from a variety of materials depending on your application and environment. Please contact a Troemner Sales Representative at [800-249-5554](tel:800-249-5554) or troemner@troemner.com for complete details and to discuss available options.



Metric Individual Weights

Weight	Part #*	Weight Diameter (inches)	Weight Height including Eyebolt (inches)
2000 kg	7902	27.00	30.00
1000 kg	7906	21.50	15.40
500 kg	7908	17.00	20.00
300 kg	7910	14.00	18.00
250 kg	7912	13.50	16.60
200 kg	7914	12.50	15.50
180 kg	7916	12.10	15.10
150 kg	7918	11.50	14.20
100 kg	7920	10.00	12.90
80 kg	7922	9.20	12.20
75 kg	7924	8.90	12.20
60 kg	7926	8.40	11.50
50 kg	7928	7.90	10.90
40 kg	7930	7.30	10.30
20 kg	7932	6.00	7.50

Avoirdupois Individual Weights

Weight	Part #*	Weight Diameter (inches)	Weight Height including Eyebolt (inches)
5000 lb	7952	28.00	31.60
2500 lb	7954	22.00	26.20
2000 lb	7955	21.00	24.00
1500 lb	7956	18.90	21.90
1000 lb	7958	16.50	19.50
800 lb	7960	15.40	18.40
500 lb	7962	13.00	16.50
400 lb	7964	12.00	15.50
250 lb	7966	9.60	12.60
200 lb	7968	8.50	11.40
140 lb	7970	7.60	10.60
100 lb	7972	6.90	9.90
75 lb	7974	5.00	6.50

* For creating a complete part #, refer to page 82.



Creating Your Complete Stainless Steel Heavy Capacity Weight Part Number

1. Select a Part

Select a part # from the preceding tables for each product that you wish to order.

2. Select an Available Class Designation

Select a class designation from the following table. For help selecting the correct class for your application, please review the "Selecting Weight Classes" section beginning on page 15.

ANSI/ASTM E617 Classes	Code	NIST Class	Code
Class 2	2	Class F	F
Class 3	3		
Class 4	4		
Class 5	5		
Class 6	6		

3. Select a Certificate Code (optional)

Select a certificate code from the following table. To learn more about Troemner's certificates, please review the "Certificate Options" section beginning on page 23.

Available Certificates	Code
NVLAP+ Accredited Certificate (available for weights up to 1000 kg (3000 lb))	W
Traceable Certificate (available for weights up to 2000 kg (5000 lb))	T

4. Create Your Complete Part Number(s)

Specify the Part Number + Class Code + Certificate Code (optional) for each product that you wish to order.





Stainless Steel Test Weights

NIST Class F 105-1



General Information

Stainless Steel Test Weights are primarily used to test commercial weighing devices by state and local weights and measures officials, device installers, and service technicians.

Stainless Steel Cylindrical Weights are legal for trade, which means their design meets specifications as outlined in NIST Handbook 105-1 and are approved to be used on legal for trade devices within the United States. Weights 5 kg/10 lb and below must be made of stainless steel of quality no lower than 300 series. Adjusting cavities are typically on the top of the weight and must be tamper resistant.

Suggested Markets

Stainless Steel Class F Test Weights may be used to test most accuracy Class III scales, all scales of Class IIII or IIII, and scales not marked with a class designation. Class F is also acceptable for use in verifying scales that have 0.1% accuracy or lower.

Class F Test Weights are primarily used to test commercial weighing devices by state and local weights and measures officials, device installers, and service technicians. Suggested markets for Stainless Steel Test Weights include, but are not limited to, Hospitals and Food Services.

Tolerance Classes

Refer to Troemner's Tolerance Chart on pages 19-20 for specific information on the tolerance of each weight in a given class. Troemner's Tolerance Chart is also available on www.troemner.com for additional reference.

Surface Finish

All surfaces have a satin finish and conform to specifications in NIST Handbook 105-1. Surface finish specifications are available on www.troemner.com for additional reference.

Material Specifications

Weight Range	Base Material	Density
1 mg - 50 mg	316 Stainless Steel	7.95 g/cm ³ at 20° C
100 mg and above	303 Stainless Steel	7.85 g/cm ³ at 20° C

Construction and General Shape

Troemner's Stainless Steel Test Weights are available in a variety of styles including flat weights, cylindrical weights, cube weights, and stackable grip handle weights. Troemner's Stainless Steel Test Weights are manufactured from grade 303 stainless steel alloy that possesses closely controlled density, low magnetic susceptibility, good stability, and resistance to corrosion and handling damage.

- **Weights 200 g, 8 oz, 0.5 lb, or 5 ozt and larger** have two-piece construction which indicates that the weight is constructed of multiple pieces of raw material. In the case of Stainless Steel Test Weights, this means that the weight body is constructed from one piece of material with an adjusting cavity. This cavity contains the adjusting material, which is typically the same material from which the weight is made. Once the weight is adjusted into tolerance, it is sealed using an aluminum cap and stainless steel back-up spacer.
- **Cylindrical weights smaller than 200 g, 8 oz, 0.5 lb or 5 ozt** are one-piece construction, which means the weight is manufactured from a single uniform piece of raw material. One-piece Stainless Steel Test Weights of this size are adjusted by polishing material off the bottom of the weight.
- **Weights 12 GN - 2 GN and 500 mg - 200 mg and .05 ozt - .005 ozt** are flat stainless steel with one side of the weight turned up for easy handling.
- **100 mg - 1 mg weights** are flat aluminum with one side of the weight turned up for easy handling.



Metric Stainless Steel Test Weights

Weight Sets (NIST Class F 105-1)

Large Metric Sets

Weight sets where the **total weight** is greater than 10 kg are supplied in a case with metal reinforced corners and bottoms with padded handles for easier carrying. Weights 200 g and above each have their own compartment within the dense foam interior. Smaller weights are contained within a smaller synthetic leather case that fits into the larger “master” carrying case. This “case-in-a-case” design helps keep smaller weights from getting lost and also allows smaller weights to be taken out of the master case and used closer to the user’s application.



Weight Set	Part #*	5000 g	2000 g	1000 g	500 g	200 g	100 g	50 g	20 g	10 g	5 g	2 g	1 g	500 mg	200 mg	100 mg	50 mg	20 mg	10 mg	5 mg	2 mg	1 mg	
5000 g (3)	TW—80—1	3																					
5000 g — 1 g	TW—5000—1	1	2	1	1	2	1	1	2	1	1	2	1										
5000 g — 1 g	TW—75—1	2	2	1	5	2	1	1	2	1	1	2	1										
5000 g — 10 mg	TW—5000—10	1	2	1	1	2	1	1	2	1	1	2	1	1	2	1	1	2	1				
5000 g — 10 mg	TW—75—10	2	2	1	5	2	1	1	2	1	1	2	1	1	2	1	1	2	1				
5000 g — 1 mg	TW—5000—01	1	2	1	1	2	1	1	2	1	1	2	1	1	2	1	1	2	1	1	1	2	1
5000 g — 1 mg	TW—75—01	2	2	1	5	2	1	1	2	1	1	2	1	1	2	1	1	2	1	1	1	2	1

* For creating a complete part #, refer to page 94.

Heavy Duty Cases are available for all Metric and Avoirdupois weight sets. See page 98.

Small Metric Sets

Weight sets where the **total weight** is less than 10 kg are supplied in sturdy plastic cases with a carrying handle. Weights 200 g and above each have their own compartment within the dense foam interior. Smaller weights are contained within a smaller synthetic leather case that fits into the larger “master” carrying case. This “case-in-a-case” design helps keep smaller weights from getting lost and also allows smaller weights to be taken out of the master case and used closer to the user’s application.



Weight Set	Part #*	2000 g	1000 g	500 g	200 g	100 g	50 g	20 g	10 g	5 g	2 g	1 g	500 mg	200 mg	100 mg	50 mg	20 mg	10 mg	5 mg	2 mg	1 mg	
50 g — 1 g	TW—50—1						1	2	1	1	2	1										
50 g — 10 mg	TW—50—10						1	2	1	1	2	1	1	2	1	1	2	1				
50 g — 1 mg	TW—50—01						1	2	1	1	2	1	1	2	1	1	2	1	1	2	1	1
100 g — 1 g	TW—100—1					1	1	2	1	1	2	1										
100 g — 10 mg	TW—100—10					1	1	2	1	1	2	1	1	2	1	1	2	1				
100 g — 1 mg	TW—100—01					1	1	2	1	1	2	1	1	2	1	1	2	1	1	2	1	1
500 g — 1 g	TW—500—1			1	2	1	1	2	1	1	2	1										
500 g — 10 mg	TW—500—10			1	2	1	1	2	1	1	2	1	1	2	1	1	2	1				
500 g — 1 mg	TW—500—01			1	2	1	1	2	1	1	2	1	1	2	1	1	2	1	1	2	1	1
1000 g — 1 g	TW—1000—1	1	1	2	1	1	2	1	1	2	1											
1000 g — 10 mg	TW—1000—10	1	1	2	1	1	2	1	1	2	1	1	2	1	1	2	1					
1000 g — 1 mg	TW—1000—01	1	1	2	1	1	2	1	1	2	1	1	2	1	1	2	1	1	2	1	1	2
2000 g — 1 g	TW—2000—1	1	1	1	2	1	1	2	1	1	2	1										
2000 g — 10 mg	TW—2000—10	1	1	1	2	1	1	2	1	1	2	1	1	2	1	1	2	1				
2000 g — 1 mg	TW—2000—01	1	1	1	2	1	1	2	1	1	2	1	1	2	1	1	2	1	1	2	1	2

* For creating a complete part #, refer to page 94.

Heavy Duty Cases are available for all Metric and Avoirdupois weight sets. See page 98.



Metric Stainless Steel Test Weights

Individual Weights (NIST Class F 105-1)

Metric Individual Weights

Individual weights are not supplied in protective cases as standard. However, for an extra charge, a polypropylene protective weight case can be specified and ordered in a variety of constructions. Please contact a Troemner Sales Representative at [800-249-5554](tel:800-249-5554) or troemner@troemner.com to discuss your specific needs.

Grip Handle Weights

Weight	Part #**
30 kg	1378
25 kg	1376
24 kg	1375
20 kg	1374
16 kg	1373
10 kg	1372
8 kg	1371
5 kg	1370

Cylindrical Weights with Groove

Weight	Part #**
5 kg	1302
4 kg	1304
3 kg	1306
2 kg	1308
1 kg	1310
500 g	1312
400 g	1313
300 g	1314
200 g	1316
100 g	1318
50 g	1320
30 g	1322
20 g	1324
10 g	1326
5 g	1328
3 g	1330
2 g	1332
1 g	1334

Metric Individual Milligram Weights

Weight	Part #**
500 mg	1336
300 mg	1338
200 mg	1340
100 mg	1342
50 mg	1344
30 mg	1346
20 mg	1348
10 mg	1350
5 mg	1352
3 mg	1354
2 mg	1356
1 mg	1358

Cube Weights

Weight	Part #**
1 kg	1301
500 g	1303
300 g	1305
200 g	1307
100 g	1309

* For creating a complete part #, refer to page 94.



Avoirdupois Stainless Steel Test Weights

Weight Sets (NIST Class F 105-1)

Large Avoirdupois Sets

Weight sets where the **total weight** is greater than 15 lb are supplied in a case with metal reinforced corners and bottoms with padded handles for easier carrying. Weights 8 oz and above each have their own compartment within the dense foam interior. Smaller weights are contained within a smaller synthetic leather case that fits into the larger “master” carrying case. This “case within a case” design helps keep smaller weights from getting lost and also allows smaller weights to be taken out of the master case and used closer to the user’s application.



Weight Set	Part #*	10 lb	5 lb	2 lb	1 lb	.5 lb	.2 lb	.1 lb	.05 lb	.02 lb	.01 lb	.005 lb	.002 lb	.001 lb	8 oz	4 oz	2 oz	1 oz	.5 oz	.2 oz	.1 oz	.05 oz	1/2 oz	1/4 oz	1/8 oz	1/16 oz	1/32 oz	
10 lb — 1/32 oz	TW—10	1	1	2	1										1	1	1	1					1	1	1	1	2	
10 lb — .001 lb	TW—10 D.	1	1	2	1	1	2	1	1	2	1	1	2	1														
10 lb — .05 oz	TW—10 D.O.	1	1	2	1										1	1	1	1	1	2	1	1						
5 lb — 1 GN	TW—45		3		5										1	1	1	1					1	1	1	1	2	
5 lb — 1/32 oz	TW—50		5		5										1	1	1	1					1	1	1	1	2	
5 lb — .001 lb	TW—50 D.		5		5	1	2	1	1	2	1	1	2	1														
5 lb — .05 oz	TW—50 D.O.		5		5										1	1	1	1	1	2	1	1						
5 lb — .001 lb	TW—50 COMBO		5		5		2	1	1	2	1	1	2	1	1	1	1	1					1	1	1	1	2	
10 lb (3)	TW—60	3																										
5 lb (6)	TW—65		6																									
10 lb — 1/32 oz	TW—75	2	1	2	1										1	1	1	1					1	1	1	1	2	
10 lb — .001 lb	TW—75 D.	2	1	2	1	1	2	1	1	2	1	1	2	1														
10 lb — .05 oz	TW—75 D.O.	2	1	2	1										1	1	1	1	1	2	1	1						
10 lb — .001 lb	TW—75 COMBO	2	1	2	1		2	1	1	2	1	1	2	1	1	1	1	1					1	1	1	1	2	
10 lb — 1/32 oz	TW—100	3	3		5										1	1	1	1					1	1	1	1	2	
10 lb — .001 lb	TW—100 D.	3	3		5	1	2	1	1	2	1	1	2	1														
10 lb — .05 lb	TW—100 D.O.	3	3		5										1	1	1	1	1	2	1	1						
10 lb — .001 lb	TW—100 COMBO	3	3		5		2	1	1	2	1	1	2	1	1	1	1	1					1	1	1	1	2	

* For creating a complete part #, refer to page 94.

Heavy Duty Cases are available for all Metric and Avoirdupois weight sets. See page 98.

Small Avoirdupois Sets

Weight sets where the **total weight** is less than 15 lb are supplied in sturdy plastic cases with a carrying handle. Weights 8 oz and above each have their own compartment within the dense foam interior. Smaller weights are contained within a smaller synthetic leather case that fits into the larger “master” carrying case. This “case-in-a-case” design helps keep smaller weights from getting lost and also allows smaller weights to be taken out of the master case and used closer to the user’s application.



Weight Set	Part #**	5 lb	2 lb	1 lb	.5 lb	.3 lb	.2 lb	.1 lb	.05 lb	.03 lb	.02 lb	.01 lb	.005 lb	.003 lb	.002 lb	.001 lb	8 oz	4 oz	2 oz	1 oz	.5 oz	.2 oz	.1 oz	.05 oz	1/2 oz	1/4 oz	1/8 oz	1/16 oz	1/32 oz
1 lb — 1/32 oz	TW—1			1													1	1	1	1					1	1	1	1	2
1 lb — .001 lb	TW—1 D.			1	1		2	1	1		2	1	1		2	1													
1 lb — .05 oz	TW—1 D.O.			1													1	1	1	1	1	2	1	1					
2 lb — 1/32 oz	TW—2		1	1													1	1	1	1					1	1	1	1	2
2 lb — .001 lb	TW—2 D.		1	1	1		2	1	1		2	1	1		2	1													
2 lb — .05 oz	TW—2 D.O.		1	1													1	1	1	1	1	2	1	1					
2 lb — 1/32 oz	TW—4		2	1													1	1	1	1					1	1	1	1	2
2 lb — .001 lb	TW—4 D.		2	1	1		2	1	1		2	1	1		2	1													
2 lb — .05 oz	TW—4 D.O.		2	1													1	1	1	1	1	2	1	1					
5 lb — 1/32 oz	TW—5	1	2	1													1	1	1	1					1	1	1	1	2
5 lb — .001 lb	TW—5 D.	1	2	1	1		2	1	1		2	1	1		2	1													
5 lb — .05 oz	TW—5 D.O.	1	2	1													1	1	1	1	1	2	1	1					
.2 lb — .001 lb	TW—15						2	1	1		2	1	1		2	1													
.3 lb — .001 lb	TW—25					1	1	1	1	1	1	1	1	1	1	1													
4 oz — 1/32 oz	TW—30																	1	1	1					1	1	1	1	2
4 oz — .05 oz	TW—35																	1	1	1	1	2	1	1					

* For creating a complete part #, refer to page 94.

Heavy Duty Cases are available for all Metric and Avoirdupois weight sets. See page 98.



Avoirdupois Stainless Steel Test Weights

Individual Weights (NIST Class F 105-1)

Avoirdupois Individual Weights

Individual weights are not supplied in protective cases as standard. However, for an extra charge, a polypropylene protective weight case can be specified and ordered in a variety of constructions. Please contact a Troemner Sales Representative at [800-249-5554](tel:800-249-5554) or troemner@troemner.com to discuss your specific needs.

Grip Handle Weights

Weight	Part #*
50 lb	1276
30 lb	1275
25 lb	1274
20 lb	1272
10 lb	1270

Cube Weights

Weight	Part #*
2 lb cube	1202
1 lb cube	1204
8 oz cube	1206
4 oz cube	1208
2 oz cube	1210

Cylindrical Weights with Groove

Weight	Part #*
10 lb	1201
5 lb	1203
4 lb	1205
3 lb	1207
2 lb	1209
1 lb	1211
12 oz	1212
8 oz	1213
4 oz	1215
2 oz	1217
1 oz	1220
1/2 oz	1222
1/4 oz	1224
1/8 oz	1226
1/16 oz	1228
1/32 oz	1230
.5 oz	1231
.3 oz	1232
.2 oz	1233
.1 oz	1234
.05 oz	1235

Weight	Part #*
.5 lb	1236
.3 lb	1238
.2 lb	1240
.1 lb	1242
.05 lb	1244
.03 lb	1246
.02 lb	1248
.01 lb	1250
.005 lb	1252
.003 lb	1254
.002 lb	1256
.001 lb	1258

* For creating a complete part #, refer to page 94.



Troy, Pennyweight, and Grain Stainless Steel Test Weights

Weight Sets (NIST Class F 105-1)



Troy and Pennyweight Sets

Weight Set	Part #*	500 ozt	200 ozt	100 ozt	50 ozt	20 ozt	10 ozt	5 ozt	2 ozt	1 ozt	.5 ozt	.2 ozt	.1 ozt	.05 ozt	.02 ozt	.01 ozt	.005 ozt	10 dwt	5 dwt	2 dwt	1 dwt	.5 dwt	.2 dwt	.1 dwt	
5 ozt — .005 ozt	TW—10 T.							1	2	1	1	2	1	1	2	1	1								
5 ozt — .1 dwt	TW—10 T.P.							1	2	1								1	1	2	1	1	2	1	
50 ozt — .005 ozt	TW—100 T.				1	2	1	1	2	1	1	2	1	1	2	1	1								
50 ozt — .1 dwt	TW—100 T.P.				1	2	1	1	2	1								1	1	2	1	1	2	1	
200 ozt — .005 ozt	TW—500 T.	1	2	1	2	1	1	2	1	1	2	1	1	2	1	1									
200 ozt — .1 dwt	TW—500 T.P.	1	2	1	2	1	1	2	1									1	1	2	1	1	2	1	
500 ozt — .005 ozt	TW—1000 T.	1	2	1	1	2	1	1	2	1	1	2	1	1	2	1	1								
500 ozt — .1 dwt	TW—1000 T.P.	1	2	1	1	2	1	1	2	1								1	1	2	1	1	2	1	

Grain Sets

Weight Set	Part #*	2000 GN	1000 GN	500 GN	200 GN	100 GN	50 GN	20 GN	10 GN	5 GN	2 GN	1 GN	.5 GN	.2 GN	.1 GN
100 GN — .1 GN	TW—100 GN					1	1	2	1	1	2	1	1	2	1
500 GN — .1 GN	TW—500 GN			1	2	1	1	2	1	1	2	1	1	2	1
1000 GN — .1 GN	TW—1000 GN	1	1	2	1	1	2	1	1	2	1	1	2	1	
2000 GN — .1 GN	TW—2000 GN	1	1	1	2	1	1	2	1	1	2	1	1	2	1

* For creating a complete part #, refer to page 94.



Troy, Pennyweight, and Grain Stainless Steel Test Weights

Individual Weights (NIST Class F 105-1)

Troy, Pennyweight and Grain Individual Weights

Individual weights are not supplied in protective cases as standard. However, for an extra charge, a polypropylene protective weight case can be specified and ordered in a variety of constructions. Please contact a Troemner Sales Representative at [800-249-5554](tel:800-249-5554) or troemner@troemner.com to discuss your specific needs.

Troy and Pennyweight Individual Weights

Weight	Part #*
500 ozt	1400
200 ozt	1402
100 ozt	1404
50 ozt	1406
20 ozt	1408
10 ozt	1410
5 ozt	1412
2 ozt	1414
1 ozt	1416
1/2 ozt	1418
1/4 ozt	1420
1/8 ozt	1422
1/16 ozt	1424
1/32 ozt	1426
.5 ozt	1428
.2 ozt	1430
.1 ozt	1432
.05 ozt	1434
.02 ozt	1436
.01 ozt	1438
.005 ozt	1440

Weight	Part #*
20 dwt	1442
10 dwt	1444
5 dwt	1446
2 dwt	1448
1 dwt	1450
.5 dwt	1452
.2 dwt	1454
.1 dwt	1456

Grain Individual Weights

Weight	Part #*
2000 GN	1500
1000 GN	1502
500 GN	1504
300 GN	1506
200 GN	1508
100 GN	1510
50 GN	1512
30 GN	1514
20 GN	1516
12 GN	1518
10 GN	1520
6 GN	1522
5 GN	1524
4 GN	1526
3 GN	1528
2 GN	1530
1 GN	1532
.5 GN	1534
.2 GN	1536
.1 GN	1538

* For creating a complete part #, refer to page 94.



Sealer Stainless Steel Test Weight Sets

Weight Sets (NIST Class F 105-1)

Metric Sealer Sets

Weight Set	Part #*	1 kg	500 g	300 g	200 g	100 g	50 g	30 g	20 g	10 g	5 g	3 g	2 g	1 g	500 mg	300 mg	200 mg	100 mg	50 mg	30 mg	20 mg	10 mg	5 mg	3 mg	2 mg	1 mg
1 kg — 1 mg	SW—140M	14	2	1	1	1	1	1	1	1	1	1	1	1	1	1	1	1	1	1	1	1	1	1	1	1
300 g — 10 g	SW—5M			1	1	1	1	1	1	1																
5 g — 1 mg	SW—1M										1	1	1	1					1	1	1	1	1	1	1	
1 kg — 1 mg	SW—20M	3	1	1	1	1	1	1	1	1	1	1	1	1	1	1	1	1	1	1	1	1	1	1	1	1

Avoirdupois Sets

Weight Set	Part #*	2 lb	1 lb	8 oz	4 oz	2 oz	1 oz	1/2 oz	1/4 oz	1/8 oz	1/16 oz	3 lb	.2 lb	.1 lb	.05 lb	.03 lb	.02 lb	.01 lb	.005 lb	.003 lb	.002 lb	.001 lb	
2 lb — 1/16 oz	SW—140	14	2	1	1	1	1	1	1	1	2												
8 oz — 1/16 oz	SW—5			1	1	1	1	1	1	1	2												
2 lb — .001 lb	SW—20	3	1	1	1	1	1	1	1	1	2	1	1	1	1	1	1	1	1	1	1	1	2
2 lb — 1/16 oz	SW—10	3	1	1	1	1	1	1	1	1	2												
.3 lb — .001 lb	SW—3											1	1	1	1	1	1	1	1	1	1	1	2

* To order individual cube weights, refer to page 90.

** For creating a complete part #, refer to page 94.

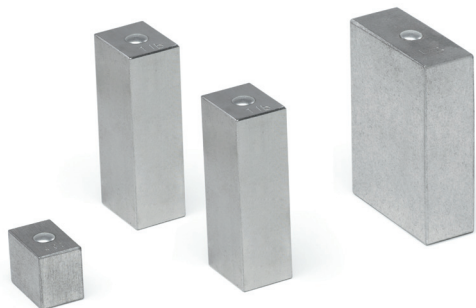



Creating Your Complete Stainless Steel Test Weight Part Number

1. Select a Part

Select a part # from the preceding tables for each product that you wish to order.

2. Class Designation

All Stainless Steel Test Weights are adjusted to NIST Class F tolerances.

3. Select a Certificate Code (optional)

Select a certificate code from the following table. To learn more about Troemner’s certificates, please review the “Certificate Options” section beginning on page 23.

Available Certificates	Code
NVLAP+ Accredited Certificate	W
Traceable Certificate	T

4. Create Your Complete Part Number(s)

Specify the Part Number + Certificate Code (optional) for each product that you wish to order.

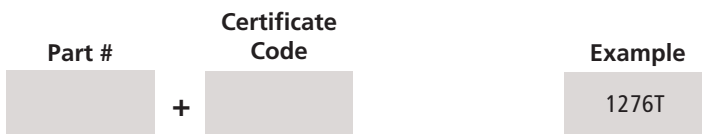



Stainless Steel Test Weights Weight Cases

Weight Cases

Troemner can provide you with the weight cases you need for proper handling and protection of your Weights and Weight Sets. Please contact a Troemner Sales Representative at [800-249-5554](tel:800-249-5554) or troemner@troemner.com to discuss your specific needs for storing and protecting your Stainless Steel Test Weights.

Polycarbonate Cases for Weight Sets

Case holds Weight Sets 5 g and below

Troemner weight sets where the largest weight is 5 g and below are supplied in attractive, durable, high quality patented polycarbonate weight cases with a compartment for each weight within the case. The case includes an inner lid that keeps weights clean and secure when in use and during shipping. There are also compartments for the forceps and brush (*not included*).

For our complete line of Weight Accessories, please see pages [129-136](#) or visit our website at www.troemner.com.



Dimensions: 3.5" Dia x 4.5" H
(8.9 cm x 11.4 cm)

Weight	Part #
500 mg — 1 mg	WSCF—0005

Polycarbonate Cases for Individual Weights

Case holds weights 10 kg, 5 kg and 4 kg

Troemner's Kilogram Cases are designed to securely hold, protect, and transport your weights sized 10 kg, 5 kg and 4 kg. Each case has a comfortable carrying handle, side latches for holding the lid in place, and a color-coded insert. Case also features urethane bumpers that gently hold weight in place.



Dimensions: 6" Dia. x 10.25" H
(15.2 cm x 26.0 cm)

Weight	Part #
10 kg	SWCF—10000
5 kg / 4 kg	SWCF—5000

Polycarbonate Cases for Individual Weights

Case holds weights 2 kg through 1 g

Troemner's **patented** Individual Polycarbonate Cases are designed to securely hold and protect your weights sized 2 kg through 1 g. As the lid is rotated open, the color-coded insert and weight move with the lid. This prevents the urethane bumper from rubbing on the weight, further protecting your weight's calibration.

Weight	Part #
2 kg	SWCF—2000
1 kg	SWCF—1000
500 g	SWCF—0500
400 g	SWCF—0400
300 g	SWCF—0300
200 g	SWCF—0200
100 g	SWCF—0100
50 g	SWCF—0050
30 g	SWCF—0030
20 g	SWCF—0020
10 g	SWCF—0010
5 g	SWCF—0005
2 g	SWCF—0002
1 g	SWCF—0001



Small size holds 200 g through 1 g
Dimensions: 2" Dia. x 2.5" H
(5.1 cm x 6.4 cm)

Large size holds 2 kg through 300 g
Dimensions: 3.5" Dia. x 4.5" H
(8.9 cm x 11.4 cm)

Polycarbonate Cases for Individual Weights

Case holds weights 500 mg through 1 mg

Troemner's **patented** Milligram Cases hold up to seven sheet metal or wire weights sized 500 mg through 1 mg. Each Milligram Case includes an inner lid that keeps weights clean and secure when in use and during shipping.

Weight	Part #
Holds up to (7) mg weights	SWCF—0000



Assembled dimensions: 2" Dia x 2.5" H
(5.1 cm x 6.4 cm)

Polypropylene Cases for Individual Weights

Troemner's Polypropylene Individual Weight Cases are made of high impact plastic. Cases are made with reinforced metal edges and corners. They also have a padded carrying handle to ensure proper handling during transport.

Visit our website at www.troemner.com for additional case dimensions.

Weight	Part #
30 kg Grip	TWF—100—30KG
25 kg Grip	TWF—100—25KG
20 kg Grip	TWF—100—20KG
16 kg Grip	TWF—100—20KG

Cases for avoirdupois weights are available. Please contact a Troemner Sales Representative at [800-249-5554](tel:800-249-5554) or troemner@troemner.com for details.



25 kg case shown
Dimensions: 8" L x 8" W x 9" H
(20.3 cm x 20.3 cm x 22.9 cm)

Heavy-Duty Cases for Individual Weights

Heavy-Duty Cases are tough, lightweight, rugged, and are designed to protect weights under any shipping circumstance. The dent and shatter resistant resin is sure to keep weights safe and secure. Each case is lined in high quality ethafoam with a custom cutout for your weight. The case is manufactured with easy press and pull latches and durable soft grip handles.

Visit our website at www.troemner.com for additional case dimensions.

Weight	Part #
20 kg Grip	SSCF—00020
10 kg Grip	SSCF—00010
5 kg Grip	SSCF—00005
5 kg Cylindrical	SSCF—00005C

Cases for avoirdupois weights are available. Please contact a Troemner Sales Representative at [800-249-5554](tel:800-249-5554) or troemner@troemner.com for details.

Heavy-Duty Cases for Weight Sets

Heavy-Duty Cases are tough, lightweight, rugged, and are designed to protect weights under any shipping circumstance. The dent and shatter resistant resin is sure to keep weights safe and secure. Each case is lined in high quality ethafoam with a custom cutout for each weight in your set. The case is manufactured with easy press and pull latches and durable soft grip handles.

Please contact a Troemner Sales Representative at [800-249-5554](tel:800-249-5554) or troemner@troemner.com for details.



10 kg case shown
Dimensions: 11.8" L x 9.8" W x 7.7" H
(30.0 cm x 24.9 cm x 19.6 cm)





Cast Iron Heavy Capacity & Grip Handle Weights

NIST Class F and ANSI/ASTM E617 Class 4, 5, 6 and 7

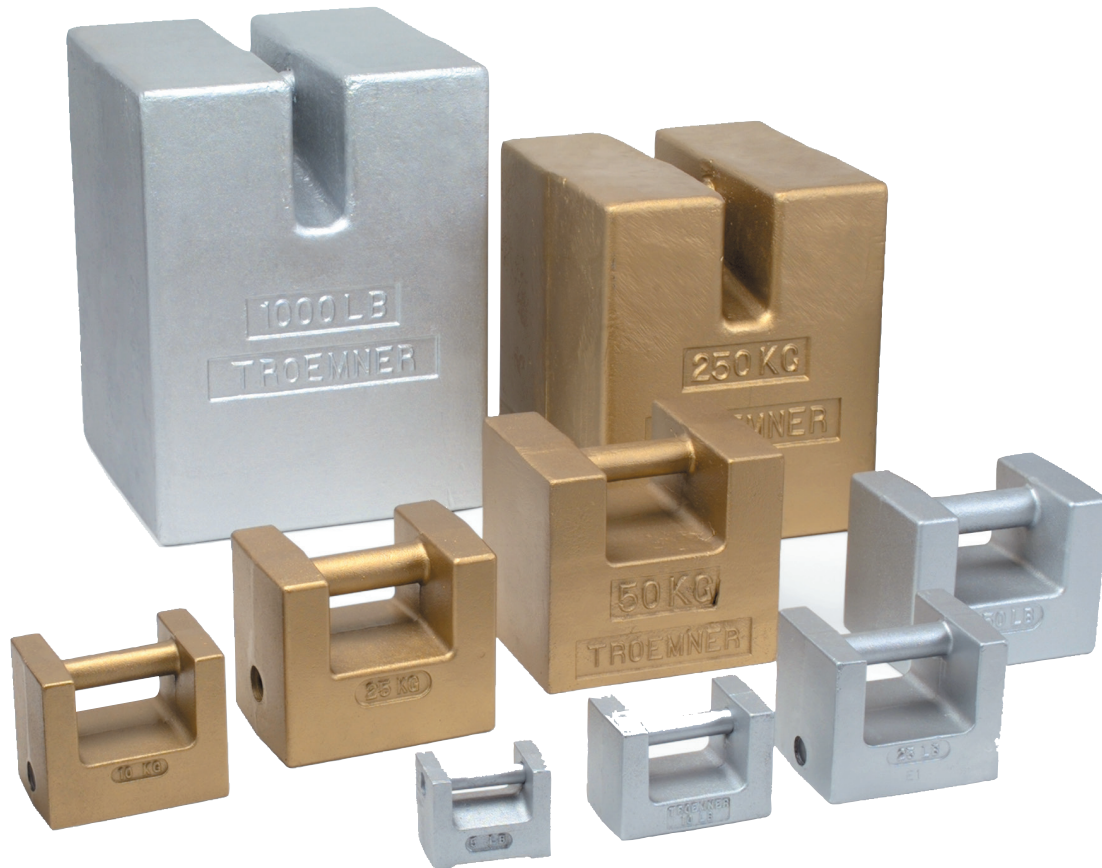

General Information

Cast Iron Grip Handle Weights larger than 5 kg/10 lb are legal for trade, which means their design is acceptable for use in checking weighing devices where the price of the item being purchased is based on its weight. Cast Iron Grip Handle weights 5 kg/10 lb and smaller are not legal for trade and are classified as ANSI/ASTM E617 Class 6. If you require a 2 kg or 5 lb weight for a legal for trade application, look for the Stainless Steel Test Weights section on page 83.

Suggested Markets

Cast Iron Grip Handle Weights are primarily used to test commercial weighing devices by state and local weights and measures officials, device installers, and service technicians. Cast Iron Grip Handle weights may be used to test most accuracy Class III scales, all scales of Class IIII or IIII, and scales not marked with a class designation. Class F is also acceptable for use in verifying scales that have a 0.1% accuracy and lower.

Tolerance Classes

Cast Iron Grip Handle Weights are adjusted to NIST Class F and ANSI/ASTM E617 Class 4, 5, 6 and 7. Refer to Troemner's Tolerance Chart on pages 19-20 for specific information on the tolerance of each weight in a given class. Troemner's Tolerance Chart is also available on www.troemner.com for additional reference.

Construction and General Shape

Troemner's Cast Iron Weights are manufactured to meet NIST Handbook 105-1 specifications. The weights are manufactured from high quality iron that meets specifications for hardness. Castings are free of cracks, pits and sharp edges and meet surface roughness requirements. Each weight has an adjusting cavity located on its side. Adjusting cavities are sealed with a lead plug and steel back-up spacer to provide a tamper resistant seal of the adjusting cavity. Weights 50 kg/100 lb and below are designed to be picked up by hand. Weights above 50 kg/100 lb are designed to be picked up by means of a hook.

Surface Finish

All surfaces are smooth and free of scratches, dents and pores as outlined in NIST Handbook 105-1. Weights are protected by a durable coat of paint to protect the casting from rusting. Paint will be hard and resistant to chipping. Color coding – gold for metric and silver for avoirdupois – is used to differentiate the weights. Surface finish specifications are available on www.troemner.com for additional reference.



Cast Iron Heavy Capacity & Grip Handle Weights

Individual Weights

Cast Iron Grip Handle Weights are not supplied in cases. Troemner manufactures a variety of custom containers and carts to properly store and transport your Cast Iron Weights and to keep them clean and protected. Containers and carts can be manufactured from a variety of materials depending on your application and environment. Please contact a Troemner Sales Representative at [800-249-5554](tel:800-249-5554) or troemner@troemner.com for complete details and to discuss available options.

Metric Individual Weights

Weight	Part #**	Length (inches)	Width (inches)	Height (inches)	Weight	Part #**	Length (inches)	Width (inches)	Height (inches)
2000 kg	9296	20.50	27.25	30.00	50 kg	9288	7.31	9.00	8.25
1000 kg	9294	20.63	20.25	21.69	25 kg	9286	5.56	7.75	6.75
500 kg	9292	14.75	14.63	20.75	20 kg	9284	5.50	7.63	5.88
250 kg	9291	12.75	12.25	14.75	10 kg	9282	4.38	6.19	5.19
200 kg	9290	12.75	12.25	12.00	5 kg*	9280	3.25	5.38	3.88
100 kg	9289	9.50	9.50	10.50	2 kg*	9278	2.38	3.88	2.81

Avoirdupois Individual Weights

Weight	Part #**	Length (inches)	Width (inches)	Height (inches)	Weight	Part #**	Length (inches)	Width (inches)	Height (inches)
5000 lb	9092	26.88	26.50	30.00	250 lb	9081	9.50	9.50	11.75
3000 lb	9090	20.19	20.31	29.50	200 lb	9083	9.56	9.19	9.19
2500 lb	9088	20.38	20.38	24.50	100 lb	9082	7.38	9.13	7.56
2000 lb	9087	20.38	20.63	19.88	50 lb	9080	5.56	8.00	6.38
1500 lb	9093	16.38	16.75	24.50	30 lb	9079	5.00	7.25	5.13
1250 lb	9091	15.00	18.25	19.00	25 lb	9078	4.75	6.19	5.19
1000 lb	9086	14.75	14.63	19.00	20 lb	9076	3.88	6.19	5.19
750 lb	9089	12.75	12.38	19.88	10 lb*	9074	3.88	5.38	3.56
500 lb	9084	12.75	12.38	13.50	5 lb*	9072	2.38	3.88	3.13

* Not legal for trade. ANSI/ASTM E617 Class 6.

** For creating a complete part #, refer to page [102](#).

Note: Above dimensions are subject to casting tolerances.



Creating Your Complete Cast Iron Weight Part Number

1. Select a "Part #"

Select a part # from the preceding tables for each product that you wish to order.

2. Select an Available Class Designation

Cast Iron weights are supplied with NIST Class F tolerances. To order a Cast Iron weight in an ANSI/ASTM E617 class listed below, add a dash and the Class Code to the end of the part number. For help selecting the correct class for your application, please review the "Selecting Weight Classes" section beginning on page 15.

ANSI/ASTM E617 Classes	Code
Class 4	4
Class 5	5
Class 6	6
Class 7	7

3. Select a Certificate Code (optional)

Select a certificate code from the following table. To learn more about Troemner's certificates, please review the "Certificate Options" section beginning on page 23.

Available Certificates	Code
NVLAP + Accredited Certificate	W
Traceable Certificate	T

4. Create Your Complete Part Number(s)

Specify the Part Number + Certificate Code (optional) for each product that you wish to order.

Part #	Certificate Code	Example
	+	9078T

Cast Iron weights are supplied with NIST Class F tolerances. To order a Cast Iron weight in an ANSI/ASTM E617 class listed above add a dash and the Class Code to the end of the part number.



Cast Iron Slotted Weights

NIST Class F and ANSI/ASTM E617 Class 4, 5, 6 and 7



General Information

Cast Iron Slotted Weights are used in a variety of applications such as pressure, torque, and tensile strength testing. Cast Iron Slotted Weights are typically used with a hanger that also has its weight calibrated so the hanger can be used as part of the overall weight under test. Several Cast Iron Slotted Weights may be used together to build up from a minimum weight to a maximum test load. The hanger weight selected should be able to accommodate the total load needed.

Suggested Markets

Cast Iron Slotted Weights are primarily used to calibrate large capacity scales.

Tolerance Classes

Cast Iron Slotted Weights are adjusted to ANSI/ASTM E617 Class 4, 5, 6 and 7. Refer to Troemner's Tolerance Chart on pages 19-20 for specific information on the tolerance of each weight in a given class. Troemner's Tolerance Chart is also available on www.troemner.com for additional reference.

Surface Finish

Troemner's Cast Iron Slotted Weights are manufactured from a high quality iron that meets ANSI/ASTM E617 hardness requirements. Castings meet ANSI/ASTM E617 surface roughness requirements and are free of cracks, pits and sharp edges. All surfaces are smooth and free of scratches, dents and pores as outlined in NIST Handbook 105-1 or ANSI/ASTM E617. Weights are protected by a durable coat of paint to protect the casting from rusting. Paint will be hard and resistant to chipping. Color coding – gold for metric and silver for avoirdupois – is used to differentiate the weights. Surface finish specifications are available on www.troemner.com for additional reference.

Construction and General Shape

Cast Iron Slotted Weights above 2 kg/5 lb have adjusting cavities. Weights below 2 kg/5 lb are adjusted by removing material from the underside of the weight. Each weight has its nominal value cast into the topside of the weight.

Weights are protected by a durable coat of paint to protect the casting from rusting. Weights 50 kg/100 lb and above are provided with two handles on opposite ends to aid in lifting.

Hangers - Cast Iron Slotted Weights are typically used with a hanger that also has its weight calibrated so the hanger can be used as part of the overall weight under test. Weight hangers are available in a variety of lengths and weight capacities. Hangers are calibrated to a mass value, and also have a capacity of how much weight can be loaded onto them. The length of each hanger and slotted weight dimensions are listed in the table on page 105. To determine which hanger will accommodate your weights, use the stem height of the hanger as the maximum height, then use the thickness dimension of each weight along with the quantity you intend to place on the hanger to determine the total height of your stack of weights. The height of your stack of weights should be less than the length of the hanger. The dimension of the hook opening is ½ inch.



Cast Iron Slotted Weights Individual Weights

Cast Iron Slotted Weights are not supplied in cases. Troemner manufactures a variety of custom containers and carts to properly store and transport your Cast Iron Slotted Weights and to keep them clean and protected. Containers and carts can be manufactured from a variety of materials depending on your application and environment. Please contact a Troemner Sales Representative at [800-249-5554](tel:800-249-5554) or troemner@troemner.com for complete details and to discuss available options.

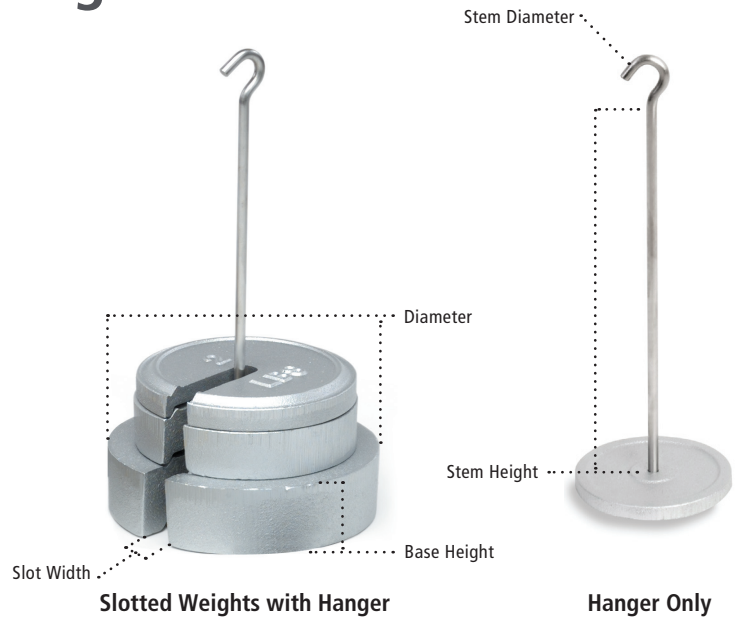

Metric Individual Weights

Weight	Part #**	Diameter (inches)	Base Height (inches)	Slot Width (inches)	Stem Diameter (inches)	Stem Height (inches)	Hanger Capacity
100 kg*	9702	17.00	4.00	1.00			
50 kg*	9700	17.00	2.00	1.00			
20 kg	9698	10.25	2.38	0.56			
10 kg	9696	8.00	1.94	0.56			
5 kg	9694	6.00	1.69	0.56			
2 kg	9692	5.00	1.00	0.56			
1 kg	9690	5.00	0.56	0.56			
500 g	9688	5.00	0.31	0.56			
200 g	9686	3.75	0.31	0.56			
2 kg Hanger	9685	5.00	0.88		0.31	36.00	250 kg
1 kg Hanger	9684	3.75	1.13		0.25	20.25	75 kg
1 kg Hanger	9682	3.75	1.13		0.25	9.25	75 kg
500 g Hanger	9680	3.75	0.38		0.25	20.25	50 kg
500 g Hanger	9678	3.75	0.44		0.25	9.25	50 kg

* Indicates weight with handles.

** For creating a complete part #, refer to page 102.

Avoirdupois Individual Weights

Weight	Part #**	Diameter (inches)	Base Height (inches)	Slot Width (inches)	Stem Diameter (inches)	Stem Height (inches)	Hanger Capacity
200 lb*	9752	17.00	3.63	1.00			
100 lb*	9750	17.00	1.88	1.00			
50 lb	9498	10.25	2.75	0.56			
25 lb	9497	10.25	1.38	0.56			
20 lb	9496	8.00	1.88	0.56			
10 lb	9494	6.00	1.50	0.56			
5 lb	9492	5.00	1.13	0.56			
2 lb	9490	5.00	0.56	0.56			
1 lb	9488	5.00	0.31	0.56			
1/2 lb	9486	3.75	0.31	0.56			
5 lb Hanger	9484	5.00	1.00		0.31	36.00	500 lb
2 lb Hanger	9482	3.75	1.13		0.25	20.25	300 lb
2 lb Hanger	9480	3.75	1.13		0.25	9.25	300 lb
1 lb Hanger	9478	3.75	0.31		0.25	20.25	200 lb
1 lb Hanger	9476	3.75	0.31		0.25	9.25	200 lb

* Indicates weight with handles.

** For creating a complete part #, refer to page 102.



Stainless Steel Slotted Weights

NIST Class F and ANSI/ASTM E617 Class **1, 2, 3, 4, 5, 6** and
OIML R 111 Class F1, F2, M1, and M2



General Information

Stainless Steel Slotted Weights are used in a variety of applications such as pressure, torque, and tensile strength testing. Stainless Steel Slotted Weights are typically used with a hanger that also has its weight calibrated so it can be used as part of the overall weight under test. Several Stainless Steel Slotted Weights may be used together to build up from a minimum weight to a maximum test load. The hanger weight selected should be able to accommodate the total load needed.

Suggested Markets

Recommended applications for Stainless Steel Slotted Weights include, but are not limited to, torque calibrations and tensile strength testing.

Tolerance Classes

Refer to Troemner's Tolerance Chart on pages 19-20 for specific information on the tolerance of each weight in a given class. Troemner's Tolerance Charts are also available on www.troemner.com for additional reference.

Surface Finish

All surfaces have a satin finish and conform to specifications in ANSI/ASTM E617. Surface finish specifications are available on www.troemner.com for additional reference.

Material Specifications

Weight Range	Base Material	Density
10 g and larger	303 Stainless Steel	7.85 g/cm ³ at 20° C
5 g and below	5052-H32 Aluminum	2.7 g/cm ³ at 20° C

Construction and General Shape

Troemner's Stainless Steel Slotted Weights are manufactured from 300 series stainless steel that meets ANSI/ASTM E617 hardness requirements. Each weight has the nominal value stamped into the top side of the weight. The interlocking design helps secure a stack of slotted weights onto a hanger. Hangers are available in a variety of lengths and weight capacities. Hooks on hangers have a 1/2 inch opening. Please contact a Troemner Sales Representative at 800-249-5554 or troemner@troemner.com for complete details and to discuss available options.

Creating Your Complete Stainless Steel Slotted Weight Part Number

1. Select a Part

Select a part # from the following tables for each product that you wish to order.

2. Class Designation

All Stainless Steel Slotted Weights are adjusted to NIST Class F tolerances or ANSI/ASTM Class 1, 2, 3, 4, 5, 6 or OIML R 111 Class F1, F2, M1, M2.

3. Select a Certificate Code (optional)

Select a certificate code from the following table. To learn more about Troemner's certificates, please review the "Certificate Options" section beginning on page 23.

Available Certificates	Code
NVLAP+ Accredited Certificate	W
Traceable Certificate	T

4. Create Your Complete Part Number(s)

Specify the Part Number + Certificate Code (optional) for each product that you wish to order.

Part #	Certificate Code	Example
	+	12924-SW

Slotted weights are supplied with NIST Class F tolerances. To order a Slotted weight in an ANSI/ASTM E617 Class 1, 2, 3, 4, 5 or 6 or OIML R 111 Class F1, F2, M1, M2 add a dash and the Class Code to the end of the part number.

* NVLAP Laboratory Code 105013-0



Stainless Steel Slotted Weights

Individual Weights

Stainless Steel Slotted Weights are not supplied in cases. Troemner manufactures a variety of custom containers and carts to properly store and transport your Stainless Steel Slotted Weights and to keep them clean and protected. Containers and carts can be manufactured from a variety of materials depending on your application and environment. Please contact a Troemner Sales Representative at [800-249-5554](tel:800-249-5554) or troemner@troemner.com for complete details and to discuss available options.

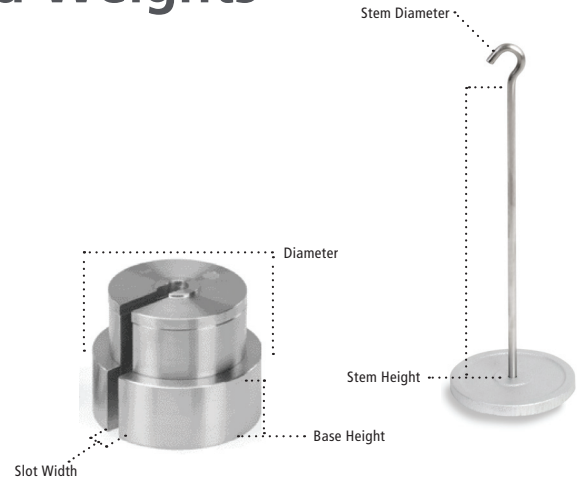

Metric Slotted Flat Individual Weights

Weight	Part #**	Diameter (inches)	Height (inches)	Slot Width (inches)
25 kg	12900—S	7.88	4.15	0.50
20 kg	12902—S	7.88	3.33	0.50
10 kg	12904—S	6.88	2.22	0.50
5 kg	12906—S	4.94	2.10	0.50
3 kg	12908—S	4.94	1.28	0.50
2 kg	12910—S	4.00	1.44	0.50
1 kg	12912—S	4.00	0.72	0.50
1/2 kg	12914—S	2.00	1.46	0.38
500 g	12916—S	2.00	1.46	0.38
300 g	12917—S	2.00	0.87	0.38
200 g	12918—S	1.63	0.94	0.38
100 g	12920—S	1.63	0.47	0.38
50 g	12922—S	1.63	0.24	0.38
20 g	12924—S	1.25	0.19	0.38
10 g	12926—S	1.25	0.09	0.38
5 g	12928—S	1.31	0.10	0.25
3 g	12929—S	1.30	0.06	0.25
2 g	12930—S	1.30	0.04	0.25
1 g	12932—S	1.32	0.02	0.25

Metric Slotted Interlocking Individual Weights

Weight	Part #**	Diameter (inches)	Height (inches)	Slot Width (inches)
25 kg	12800—S	7.88	4.27	0.50
20 kg	12802—S	7.88	3.47	0.50
10 kg	12804—S	6.88	2.31	0.50
5 kg	12806—S	4.94	2.32	0.50
3 kg	12808—S	4.94	1.37	0.50
2 kg	12810—S	4.00	1.54	0.50
1 kg	12812—S	4.00	0.82	0.50
1/2 kg	12814—S	4.00	0.46	0.50
500 g	12816—S	4.00	0.46	0.50
300 g	12817—S	3.00	0.47	0.38
200 g	12818—S	2.00	0.71	0.38
100 g	12820—S	2.00	0.41	0.38
50 g	12822—S	1.63	0.34	0.38

** For creating a complete part #, refer to page 108.

Avoirdupois Slotted Flat Individual Weights

Weight	Part #**	Diameter (inches)	Height (inches)	Slot Width (inches)
50 lb	12700—S	7.88	3.78	0.50
25 lb	12702—S	6.88	2.52	0.50
20 lb	12704—S	6.88	2.52	0.50
10 lb	12706—S	4.94	1.99	0.50
5 lb	12708—S	4.00	1.55	0.50
3 lb	12709—S	4.00	0.93	0.50
2 lb	12710—S	4.00	0.62	0.50
1 lb	12712—S	2.00	1.33	0.38
0.5 lb	12714—S	1.63	1.08	0.38
0.2 lb	12716—S	1.63	0.45	0.38
0.1 lb	12718—S	1.63	0.22	0.38
8 oz	12720—S	1.63	1.08	0.38
4 oz	12722—S	1.63	0.54	0.38
2 oz	12724—S	1.63	0.27	0.38
1 oz	12726—S	1.25	0.26	0.38
1/2 oz	12728—S	1.25	0.13	0.38
1/4 oz	12730—S	1.25	0.06	0.38
1/8 oz	12732—S	1.25	0.03	0.38
1/16 oz	12734—S	1.25	0.01	0.38
1/32 oz	12736—S	1.25	0.01	0.38

Avoirdupois Slotted Interlocking Individual Weights

Weight	Part #**	Diameter (inches)	Height (inches)	Slot Width (inches)
50 lb	12600—S	7.88	3.88	0.50
25 lb	12602—S	6.98	2.55	0.50
20 lb	12604—S	6.88	2.12	0.50
10 lb	12606—S	4.95	2.07	0.50
5 lb	12608—S	4.00	1.65	0.50
3 lb	12609—S	4.00	1.03	0.50
2 lb	12610—S	4.00	0.72	0.50
1 lb	12612—S	2.00	1.42	0.38
0.5 lb	12614—S	1.63	1.17	0.38
0.2 lb	12616—S	2.00	0.38	0.38
0.1 lb	12618—S	1.63	0.31	0.38
8 oz	12620—S	1.63	1.17	0.38
4 oz	12622—S	1.25	0.64	0.38
2 oz	12624—S	1.63	0.37	0.38

** For creating a complete part #, refer to page 108.



Stainless Steel Hook Weights

NIST Class F, ANSI/ASTM E617 Class **1, 2, 3, 4, 5, 6** and
OIML R 111 Class F1, F2, M1, and M2



General Information

Stainless Steel Hook Weights are used in a variety of applications such as pressure, torque, and tensile strength testing. Hook Weights are available as hook top, hook top and bottom, or hook top and bottom with a recessed bottom.

Suggested Markets

Recommended applications for Stainless Steel Hook Weights include, but are not limited to, blood collection.

Tolerance Classes

Refer to Troemner's Tolerance Chart on pages 19-20 for specific information on the tolerance of each weight in a given class. Troemner's Tolerance Chart is also available on www.troemner.com for additional reference.

Surface Finish

All surfaces have a satin finish and conform to specifications in ANSI/ASTM E617. Surface finish specifications are available on www.troemner.com for additional reference.

Material Specifications

Weight Range	Base Material	Density
All Sizes	303 Stainless Steel	7.85 g/cm ³ at 20° C

Construction and General Shape

Troemner's Stainless Steel Hook weights are manufactured from 300 series stainless steel. Each weight has the nominal value stamped into the top side of the weight.

Hook Top Only - Hook Top Weights are flat on top with a stationary hook in the center of the weight.

Hook Top and Bottom - Hook Top and Bottom Weights have a flat top and bottom with a stationary hook on either end of the weight.

Loose Hook Top and Bottom - Loose Hook Top and Bottom Weights have a flat top with recessed bottom which allows the hook to move freely through the weight. The recessed bottom also allows the weight to sit flat on an even surface.

Creating Your Complete Stainless Steel Hook Weight Part Number

1. Select a Part

Select a part # from the following tables for each product that you wish to order.

2. Class Designation

All Stainless Steel Hook Weights are adjusted to NIST Class F tolerances or ANSI/ASTM Class 1, 2, 3, 4, 5, 6 or OIML R 111 Class F1, F2, M1, M2.

3. Select a Certificate Code (optional)

Select a certificate code from the following table. To learn more about Troemner's certificates, please review the "Certificate Options" section beginning on page 23.

Available Certificates	Code
NVLAP+ Accredited Certificate	W
Traceable Certificate	T

4. Create Your Complete Part Number(s)

Specify the Part Number + Certificate Code (optional) for each product that you wish to order.

Part #	Certificate Code	Example
	+	12300-ST

Hook weights are supplied with NIST Class F tolerances. To order a Hook weight in an ANSI/ASTM E617 Class 1, 2, 3, 4, 5 or 6 and OIML R 111 Class F1, F2, M1, M2 add a dash and the Class Code to the end of the part number.

* NVLAP Laboratory Code 105013-0



Stainless Steel Hook Weights

Individual Weights

Stainless Steel Hook Weights are not supplied in cases. Troemner manufactures a variety of custom containers and carts to properly store and transport your Stainless Steel Hook Weights and to keep them clean and protected. Containers and carts can be manufactured from a variety of materials depending on your application and environment. Please contact a Troemner Sales Representative at [800-249-5554](tel:800-249-5554) or troemner@troemner.com for complete details and to discuss available options.

Metric Hook Top Only Weights

Weight	Part #*	Diameter (inches)	Height (inches)
25 kg	12300—S	5.97	9.11
20 kg	12302—S	5.98	8.13
10 kg	12304—S	4.95	5.53
5 kg	12306—S	3.73	4.50
3 kg	12308—S	2.74	5.06
2 kg	12310—S	2.61	3.96
1 kg	12312—S	1.99	3.56
1/2 kg	12314—S	1.49	3.29
500 g	12316—S	1.49	3.29
300 g	12317—S	1.36	2.65
200 g	12318—S	1.12	2.61
100 g	12320—S	0.87	1.95
50 g	12322—S	0.74	1.52
20 g	12324—S	0.50	1.34
10 g	12326—S	0.43	1.00
5 g	12328—S	0.45	1.75
3 g	12329—S	0.47	0.97
2 g	12330—S	0.41	0.75
1 g	12332—S	0.38	0.75

Metric Hook Top and Bottom Weights

Weight	Part #*	Diameter (inches)	Height (inches)
25 kg	12400—S	5.97	11.35
20 kg	12402—S	5.98	8.13
10 kg	12404—S	4.47	7.45
5 kg	12406—S	3.73	5.69
3 kg	12408—S	2.74	6.13
2 kg	12410—S	2.62	5.00
1 kg	12412—S	1.99	4.62
1/2 kg	12414—S	1.49	4.32
500 g	12416—S	1.49	4.32
300 g	12417—S	1.36	3.68
200 g	12418—S	1.12	3.63
100 g	12420—S	0.87	2.54
50 g	12422—S	0.74	2.14
20 g	12424—S	0.50	1.81
10 g	12426—S	0.43	1.37
5 g	12428—S	0.45	1.75
3 g	12429—S	0.47	0.97
2 g	12430—S	0.41	0.75
1 g	12432—S	0.38	0.75

* For creating a complete part #, refer to page 112.

Metric Loose Hook Top and Bottom Weights

Weight	Part #*	Diameter (inches)	Height (inches)
25 kg	12500—S	5.75	10.25
20 kg	12502—S	5.70	7.50
10 kg	12504—S	4.47	6.35
5 kg	12506—S	3.23	6.29
3 kg	12508—S	2.99	4.80
2 kg	12510—S	2.73	4.15
1 kg	12512—S	2.23	3.60
1/2 kg	12514—S	1.73	3.15
500 g	12516—S	1.73	3.15
300 g	12517—S	1.48	2.92
200 g	12518—S	1.24	2.70
100 g	12520—S	0.99	2.40
50 g	12522—S	0.80	2.23
20 g	12524—S	0.68	1.70
10 g	12526—S	0.49	1.63
5 g	12528—S	0.45	1.75
3 g	12529—S	0.47	0.97
2 g	12530—S	0.41	0.75
1 g	12532—S	0.38	0.75

* For creating a complete part #, refer to page 112.



Avoirdupois Hook Top Only Weights

Weight	Part #*	Diameter (inches)	Height (inches)
50 lb	12000—S	5.97	8.45
25 lb	12002—S	4.47	7.08
20 lb	12004—S	4.95	4.60
10 lb	12006—S	3.24	5.75
5 lb	12008—S	2.50	4.69
3 lb	12009—S	2.50	3.25
2 lb	12010—S	1.87	3.62
1 lb	12012—S	1.49	3.04
0.5 lb	12014—S	1.24	2.40
0.2 lb	12016—S	0.87	1.83
0.1 lb	12018—S	0.74	1.45
8 oz	12020—S	1.24	2.40
4 oz	12022—S	0.87	2.09
2 oz	12024—S	0.74	1.61
1 oz	12026—S	0.62	1.25
1/2 oz	12028—S	0.43	1.25
1/4 oz	12030—S	0.45	1.75
1/8 oz	12032—S	0.47	0.97
1/16 oz	12034—S	0.41	0.75
1/32 oz	12036—S	0.38	0.75

Avoirdupois Hook Top and Bottom Weights

Weight	Part #*	Diameter (inches)	Height (inches)
50 lb	12100—S	5.97	10.80
25 lb	12102—S	4.47	8.58
20 lb	12104—S	4.23	8.00
10 lb	12106—S	3.23	7.35
5 lb	12108—S	2.48	5.71
3 lb	12109—S	2.24	5.71
2 lb	12110—S	1.87	4.67
1 lb	12112—S	1.49	3.89
0.5 lb	12114—S	1.24	3.32
0.2 lb	12116—S	0.87	2.42
0.1 lb	12118—S	0.74	2.06
8 oz	12120—S	1.24	3.32
4 oz	12122—S	0.87	2.72
2 oz	12124—S	0.74	2.25
1 oz	12126—S	0.55	1.95
1/2 oz	12128—S	0.37	1.82
1/4 oz	12130—S	1.19	1.19
1/8 oz	12132—S	0.47	0.97
1/16 oz	12134—S	0.41	0.75
1/32 oz	12136—S	0.38	0.75

* For creating a complete part #, refer to page 112.

Avoirdupois Loose Hook Top and Bottom Weights

Weight	Part #*	Diameter (inches)	Height (inches)
50 lb	12200—S	5.97	8.45
25 lb	12202—S	4.50	5.75
20 lb	12204—S	4.95	4.60
10 lb	12206—S	3.23	5.85
5 lb	12208—S	2.60	4.88
3 lb	12209—S	2.37	4.01
2 lb	12210—S	1.98	4.00
1 lb	12212—S	1.60	3.30
0.5 lb	12214—S	1.24	2.40
0.2 lb	12216—S	0.99	2.30
0.1 lb	12218—S	0.80	2.14
8 oz	12220—S	1.11	3.23
4 oz	12222—S	0.87	2.81
2 oz	12224—S	0.74	2.35
1 oz	12226—S	0.55	2.41
1/2 oz	12228—S	0.55	1.95
1/4 oz	12230—S	0.45	1.75
1/8 oz	12232—S	0.47	0.97
1/16 oz	12234—S	0.41	0.75
1/32 oz	12236—S	0.38	0.75



* For creating a complete part #, refer to page 112.



Economical Stainless Steel Weights

ANSI/ASTM E617 Class 7



General Information

Troemner Economical Stainless Steel Weights and Weight Sets are economical, quality weights. Individual weights are available from 1 mg through 2000 g. Weight Sets are designed to achieve any total mass by combining smaller masses. The makeup of Economical Stainless Steel Weight Sets varies. Weights are adjusted to tolerances specified by ANSI/ASTM E617 Class 7.

Suggested Markets

Suggested Markets for Economical Stainless Steel Weights include, but are not limited to, educational markets. Weights are provided in three designs: cylindrical, hooked and slotted to meet your specific needs. Slotted and hook weights are also available in Newton denominations from 0.1 N through 10 N (5 N for slotted weights).

Tolerance Classes

Economical Stainless Steel Weights are adjusted to ANSI/ASTM E617 Class 7. Refer to Troemner's Tolerance Chart on pages 19-20 for specific information on the tolerance of each weight in a given class. Troemner's Tolerance Chart is also available on www.troemner.com for additional reference. For Newton weights, use the closest corresponding metric tolerance.

Surface Finish

All surfaces are satin finish and conform to specifications in ANSI/ASTM E617. Surface finish specifications are available on www.troemner.com for additional reference.

Material Specifications

Weight Range	Base Material	Density
1 mg - 50 mg	316 Stainless Steel	7.95 g/cm ³ at 20° C
100 mg and above	303 Stainless Steel	7.85 g/cm ³ at 20° C

Construction and General Shape

Cylindrical Weights – Weights 1 g and above are carefully manufactured from stainless steel and are cylindrical in shape for easy gripping. Weights 1 g to 100 g are of one-piece construction and are adjusted during manufacture by removing material from the bottom of the weight. Weights 200 g through 2 kg have an adjusting cavity on the top that is sealed with a plug. Economical Stainless Steel Weights 1 g and above are perfectly flat on top to stack easily on center. Weights 500 mg and lower are made of stainless steel or aluminum and are flat, one-piece construction with one side turned up to make them easy to handle with forceps. 500 mg and 200 mg weights are made of stainless steel while weights 100 mg and below are made of aluminum.

Slotted Weights – Weights 10 g through 500 g (0.1 N through 5 N) are made of stainless steel, and weights 1 g through 5 g are made of aluminum. All slotted weights have an approximate diameter of 1¹/₄ inches and have a slot opening width of 1/4 inch. A hanger is also available to stack and hang your slotted weights. The overall length of the hanger is approximately 7¹/₄ inches with a usable length of 7 inches. The hanger is designed to accept the slotted weights.

Hook Weights – Weights range from 10 g through 1 kg (0.1 N through 10 N) and are made of stainless steel. On all hook weights, except the 10 g (0.1 N), there is a hook on the top and the bottom of the weight so the weights can be hooked together. The 10 g (0.1 N) hook weight has a hook on the top of the weight only. The design of the hook weight allows the bottom hook to be recessed in the bottom, so the hooked weights can be set on a flat surface without tipping over. The opening of the hook for each weight is 1/2 inch.

All Economical Stainless Steel weights regardless of design are marked with their nominal mass value.



Metric & Newton Economical Stainless Steel Weights Weight Sets

Cylindrical Metric Sets

Cylindrical Economical Stainless Steel Weight Sets are supplied in rugged, plastic cases with a locking latch and a compartment for each weight in the case or a plastic weight block with a compartment for each weight.

Weight Set	Part #*	2000 g	1000 g	500 g	200 g	100 g	50 g	20 g	10 g	5 g	2 g	1 g	500 mg	200 mg	100 mg	50 mg	20 mg	10 mg	5 mg	2 mg	1 mg	
2000 g — 1 g	338S	1	1	1	2	1	1	2	1	1	2	1										
2000 g — 10 mg	338—10S	1	1	1	2	1	1	2	1	1	2	1	1	2	1	1	2	1				
2000 g — 1 mg	338—01S	1	1	1	2	1	1	2	1	1	2	1	1	2	1	1	2	1	1	2	1	1
1000 g — 1 g	301S		1	1	2	1	1	2	1	1	2	1										
1000 g — 1 g	313S		1	1	2	1	1	2	1	1	2	1										
1000 g — 10 mg	313—10S		1	1	2	1	1	2	1	1	2	1	1	2	1	1	2	1				
1000 g — 1 mg	313—01S		1	1	2	1	1	2	1	1	2	1	1	2	1	1	2	1	1	2	1	1
500 g — 1 g	300S			1	2	1	1	2	1	1	2	1										
500 g — 1 g	312S			1	2	1	1	2	1	1	2	1										
500 g — 10 mg	312—10S			1	2	1	1	2	1	1	2	1	1	2	1	1	2	1				
500 g — 1 mg	312—01S			1	2	1	1	2	1	1	2	1	1	2	1	1	2	1	1	2	1	1
200 g — 1 g	314S				1	1	1	2	1	1	2	1										
200 g — 10 mg	314—10S				1	1	1	2	1	1	2	1	1	2	1	1	2	1				
200 g — 1 mg	314—01S				1	1	1	2	1	1	2	1	1	2	1	1	2	1	1	2	1	1
100 g — 1 g	311S					1	1	2	1	1	2	1										
100 g — 10 mg	311—10S					1	1	2	1	1	2	1	1	2	1	1	2	1				
100 g — 1 mg	311—01S					1	1	2	1	1	2	1	1	2	1	1	2	1	1	2	1	1
50 g — 1 g**	341—3S						1	1	2	1	2	1										
50 g — 1 g	310S						1	2	1	1	2	1										
50 g — 100 mg**	341—2S						1	1	2	1	2	1	1	2	1							
50 g — 10 mg	310—10S						1	2	1	1	2	1	1	2	1	1	2	1				
50 g — 10 mg	341S						1	1	2	1	2	1	1	2	1	1	2	1				
50 g — 1 mg	310—01S						1	2	1	1	2	1	1	2	1	1	2	1	1	2	1	1
500 mg — 1 mg	318S												1	2	1	1	2	1	1	2	1	1

* For creating a complete part #, refer to page 124.

** Weight sets 341-2S and 341-3S are not adjusted to Class 7. They have approximately 1% accuracy.

Apothecary Sets

50 g — 1 g and all dram, scruple and ounce weights except ½ scruple are one-piece with handling knob. ½ scruple is flat and round. 500 mg and below are flat with one end turned up for easy handling. Grain weights are flat wire.

Weight Set	Part #*	2 oz	1 oz	1/2 oz	2 dram	1 dram	1/2 dram	2 scruple	1 scruple	1/2 scruple	5 GN	4 GN	3 GN	2 GN	1 GN	1/2 GN	50 g	20 g	10 g	5 g	2 g	1 g	500 mg	200 mg	100 mg	50 mg	20 mg	10 mg
50 g — 10 mg																	1	2	1	1	2	1	1	2	1	1	2	1
2 oz ap — 1/2 oz ap	22ES	1	1	1																								
2 dram — 1/2 GN					1	1	1	1	1	1	1	1	1	1	1	1												

Student Metric Sets

Economical 50 g - 1 g weight set supplied in a plastic bag.

Weight Set	Part #*	50 g	20 g	10 g	5 g	2 g	1 g
50 g — 1 g (set supplied in a plastic bag)	61005—01	1	1	2	1	2	1

* For creating a complete part #, refer to page 124.



Economical Stainless Steel Slotted Sets

Slotted Weight Sets are supplied either on a rack with a carrying handle or in a plastic case with a foam interior. The more popular choice for customers is the weight rack.

Metric Slotted Sets

Weight Set	Part #*	500 g	200 g	100 g	50 g	20 g	10 g	5 g	2 g	1 g
500 g — 10 g*	53503S	1	2	1	1	2	1			
500 g — 10 g	53504S	1		5	1	2	1			
500 g — 1 g*	53505S	1	2	1	1	2	1	1	2	1
500 g — 1 g	53506S	1		5	1	2	1	1	2	1
50 g	56207S	Weight Hanger								

* Contains two 200 g and two 20 g weights and one 100 g.

Newton Slotted Sets

Weight Set	Part #*	5 N	1 N	0.5 N	0.2 N	0.1 N
5 N — 0.1 N	53504—1S	1	5	1	2	1
5 N	56207 NS	Weight Hanger				



Economical Stainless Steel Hook Sets

Hook Weight Sets are supplied in an open plastic block with a compartment for each weight. There is no lid on the block. Individual Hook Weights are not supplied in a protective case.

Metric Hook Sets

Weight Set	Part #*	1000 g	500 g	200 g	100 g	50 g	20 g	10 g
1000 g — 10 g	56206S	1	1	2	1	1	2	1

Newton Hook Sets

Weight Set	Part #*	10 N	5 N	2 N	1 N	0.5 N	0.2 N	0.1 N
10 N — 0.1 N	56206—01S	1	1	2	1	1	2	1

* For creating a complete part #, refer to page 124.



Economical Stainless Steel Weights

Individual Weights

Metric Individual Weights

Individual weights are not supplied in protective cases as standard. However, for an extra charge, a polypropylene protective weight case can be specified and ordered in a variety of constructions. Please contact a Troemner Sales Representative at [800-249-5554](tel:800-249-5554) or troemner@troemner.com to discuss your specific needs.



Cylindrical Metric Weights

Weight	Part #*
2000 g	61026S
1000 g	61016S
500 g	61055S
200 g	61025S
100 g	61015S
50 g	61054S
20 g	61024S
10 g	61014S
5 g	61053S
2 g	61023S
1 g	61013S

Slotted Metric Weights

Weight	Part #*
500 g	53500S
200 g	53200S
100 g	53100S
50 g	53050S
20 g	53020S
10 g	53010S
5 g	53005S
2 g	53002S
1 g	53001S

Hook Metric Weights

Weight	Part #*
1000 g	51000S
500 g	50500S
200 g	50200S
100 g	50100S
50 g	50050S
20 g	50020S
10 g	50010S

* For creating a complete part #, refer to page 124.

Metric Individual Milligram Weights

Troemner Milligram Weights are available in sheet metal construction.

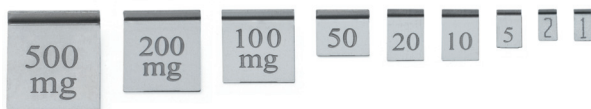

Weight	Part #*
500 mg	61052S
200 mg	61022S
100 mg	61012S
50 mg	61051S
20 mg	61021S
10 mg	61011S
5 mg	61050S
2 mg	61020S
1 mg	61010S

Newton Individual Weights

Newton Individual Weights are not supplied in protective cases as standard. However, for an extra charge, a polypropylene protective weight case can be specified and ordered in a variety of constructions. Please contact a Troemner Sales Representative at [800-249-5554](tel:800-249-5554) or troemner@troemner.com to discuss your specific needs.

Newton Hook Individual Weights

Weight	Part #*
10 N	51000—01S
5 N	50500—01S
2 N	50200—01S
1 N	50100—01S
0.5 N	50050—01S
0.2 N	50020—01S
0.1 N	50010—10S

Newton Slotted Individual Weights

Weight	Part #*
5 N	53500—01S
1 N	53100—01S
0.5 N	53050—01S
0.2 N	53020—01S
0.1 N	53010—05

* For creating a complete part #, refer to page [124](#).



Creating Your Complete Economical Stainless Steel Weight Part Number

1. Select a Part

Select a part # from the preceding tables for each product that you wish to order.

2. Class Designation

All Economical Stainless Steel Weights are adjusted ANSI/ASTM E617 Class 7 tolerances.

3. Select a Certificate Code (optional)

Select a certificate code from the following table. To learn more about Troemner's certificates, please review the "Certificate Options" section beginning on page 23.

Available Certificates	Code
Traceable Certificate	T

4. Create Your Complete Part Number(s)

Specify the Part Number + Certificate Code (optional) for each product that you wish to order.

Part #	Certificate Code	Example
	+	61026ST



Economical Stainless Steel Weights



Custom Weights and Cases



Custom Weights General Information

Meeting your special weight needs is a Troemner specialty. We can custom make precisely the weight you need for your unique application. If you cannot find a weight or weight set to fit your individual weight or weight set within the preceding pages, Troemner is able to create a customized weight to fit your needs.

- **Any Size**
From 50 micrograms through 2000 kg (0.0001 oz through 5000 lb)
- **Any Denomination**
Metric, avoirdupois, troy ounce, grain, pennyweight, carat, other standards or even custom units.
- **Any Tolerance**
Including all ANSI/ASTM, NIST, OIML classes or special tolerances such as Troemner UltraClass Series or a customer-designated tolerance.
- **Any Material**
Including stainless steel, aluminum, cast iron, nichrome, steel, gold, silver, titanium, and more.
- **Any Shape**
Slotted, hook, bar, cylindrical, flat, dish, cube, etc. We can create drawings and prints based on customer input or can work from customer supplied prints.
- **Engineering Services**
Troemner can provide assistance and guidance in helping you design a weight for your specific application or we can design a weight and provide drawings based on your design input.

Please contact a Troemner Sales Representative at [800-249-5554](tel:800-249-5554) or troemner@troemner.com for a no obligation quotation.

Custom Weight Case General Information

If you cannot find a case to fit your individual weight or weight set within the preceding pages, Troemner is able to create a customized case to fit your needs. Generally, Custom Cases can be made for any weight style and size and are available in a variety of materials. The following table names each Custom Weight Case material available. Please contact a Troemner Sales Representative at [800-249-5554](tel:800-249-5554) or troemner@troemner.com for specifications and a no obligation quotation.

Please note: Weight cases are not intended to be used as shipping containers unless specified. When you ship your weights to be calibrated, the weight and weight sets must be over packed in larger containers and/or cartons to protect your weights. Contact Troemner to discuss shipping cases to return your weights for recalibration at [800-249-5554](tel:800-249-5554) or troemner@troemner.com.



Custom Weight Case Material

Polycarbonate

Polypropylene

Wood

Stainless Steel

Aluminum

Heavy-Duty



Custom Weights and Cases



Custom Weight Carts



Shown from left to right: Stainless Steel Storage Cart, Stainless Steel Calibrated Storage Cart with double handles, and Stainless Steel Calibrated Weight Cart.

General Information

Troemner Custom Weight Carts are made of stainless steel with all stainless steel hardware as well. The carts can be calibrated to a specific weight if required. Troemner Custom Weight Carts are ideal for clean room use and create a means to easily transport large weights from one balance to another, one room to another, or simply for storage of weights in a set. Custom Weight Cart features include:

- All welded construction with a hinged lid and push handle.
- Custom PVC inserts are provided for precision weights with individual pockets for each weight.
- Polyurethane wheels with brakes, two are swivel and two are fixed

To order a Customer Weight Cart contact a Troemner Sales Representative at [800-249-5554](tel:800-249-5554) or troemner@troemner.com with your specifications.

Stainless Steel Calibrated Weight Cart

Troemner calibrated weight carts are made of stainless steel. These carts can be calibrated to a specific weight and are designed for use on platform scales. Custom sizes and weights are available. Multiple carts can be manufactured to test heavy capacity scales. Calibrated Carts can be purchased with a NVLAP+ Accredited Certificate and are available in ANSI/ASTM Class 4 and NIST F.



Stainless Steel Storage Cart

Troemner Custom Weight Carts are made of stainless steel with all hardware being stainless steel as well. The carts can be calibrated to a specific weight if required. Troemner Custom Weight Carts are ideal for clean room use and create a means to easily transport large weights from one balance to another, one room to another, or simply for storage of weights in a set.



PVC Insert for Stainless Steel Storage Cart

Custom PVC inserts are provided for precision weights with individual compartments for each weight.





Weight Accessories



General Information

Troemner can provide you with all the accessories you need for proper handling and protection of both your individual weights and weight sets in all weight styles. Complete accessory kits, brushes and cloths, weight lifters and forks, gloves, and forceps are available for most weight styles. Accessories designed for specific weight styles are noted. Please contact a Troemner Sales Representative at [800-249-5554](tel:800-249-5554) or troemner@troemner.com for questions and to ask about customization. Accessories are available for the following styles of weights:



Analytical Precision Weights



OIML Precision Weights



Electronic Balance Weights



Stainless Steel Test Weights



Stainless Steel Heavy Capacity Weights



Cast Iron Grip Handle Weights



Stainless Steel Slotted Weights



Stainless Steel Hook Weights



Stainless Steel Economical Weights



Custom Weights

Complete Accessory Kit

The Complete Accessory Kit includes one of each: clear polycarbonate forceps (WA056), small brush (WA195), wide brush (WA200), nylon glove (WA168), and microfibre cloth (WA600). The plastic forceps included are designed for weights 1 mg through 200 g only. The glove is provided for handling weights 500 g through 5 kg.



Dimensions: 3.5" Dia. x 4.5" H
(8.9 cm x 11.4 cm)

Small brush is not pictured.



Analytical Precision Weights



OIML Precision Weights

Accessory

Part #

Complete Accessory Kit

SWCK—ACCS

Brushes and Cloth

Brushes and cloth are designed to remove visible particles from your weights. Small 100 mm brushes are used for weights 1 mg through 500 g. Wide, medium, large and extra large brushes are designed for weights 1 kg through 5 kg. The brushes can be used on all weight styles except Cast Iron. The microfibre cloth is recommended for use on stainless steel weights only.



Small Brush



Wide Brush

Any Weight Style (excluding Cast Iron Weights)										
Accessory									Part #	
Small Brush (110 mm)										WA195
Wide Brush (115 mm)										WA200
Microfibre Cleaning Cloth										WA600

Gloves

Leather gloves are designed for large industrial weights and are sold as a single glove. Please specify left or right when ordering. Nylon gloves are sold as a pair and feature a grip tip for secure lifting. Cotton gloves are sold individually and are designed to fit either the left or right hand.



Nylon Glove (sold in pairs)



Leather Glove (sold individually)



Cotton Glove (sold individually)

										Any Weight Style
Accessory										Part #
Nylon Glove (Pair)										WA168
Cotton Glove										WA061
Leather Glove (Specify left or right) Recommended for Cast Iron Weights										WA436

Weight Lifters and Forks

Troemner offers a variety of lifters and forks of various materials to suit your applications. Plastic weight forks are constructed of high quality polycarbonate and are designed specific to the size and style of the weight. Aluminum weight forks and lifters are constructed with an aluminum handle and a PVC lifting base. Steel lifters with polyamide coating are designed for ergonomic lifting of large weights. Also available are steel lifters covered with a gentle, non-abrasive chamois material.



Aluminum Weight Lifter



Aluminum T-Handle Lifter

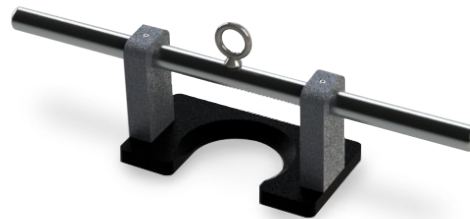

Aluminum 50 kg Weight Lifter



Polyamide Coated Steel Lifter



Steel Lifter with Chamois Cover



Polycarbonate Weight Fork

Stainless Steel Weight Racks

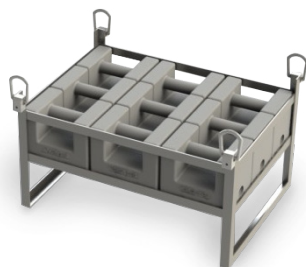

Troemner offers custom Stainless Steel Weight Racks for your Cast Iron or Precision Weights. These racks can be easily lifted using a pallet or sling. Please contact a Troemner Sales Representative at [800-249-5554](tel:800-249-5554) or troemner@troemner.com with your specifications.



Analytical Precision Weights

Accessory	Part #
Wood Weight Fork for 200 g — 500 g	WA001
Polycarbonate Weight Fork for 500 g — 2 kg	WA219
Polyamide Handle for 20 kg, 25 kg, 30 kg	WA206
Polyamide Handle for 5 kg, 10 kg	WA214
Chamois Covered Large Weight Lifter for 10 kg — 25 kg	WA404
Chamois Covered Small Weight Lifter for 1 kg — 5 kg	WA405
Aluminum Weight Lifter for 50 kg	WA455



OIML Precision Weights

Accessory	Part #
Polycarbonate Weight Fork for 2 kg	WA217
Polycarbonate Weight Fork for 500 g — 1 kg	WA216
Aluminum Weight Fork for 10 kg	WA452
Aluminum Weight Fork for 5 kg	WA451
Aluminum Weight Fork for 2 kg	WA450
Aluminum Weight Fork for 500 g — 1 kg	WA449
Polyamide Handle for 5 kg	WA204
Polyamide Handle for 2 kg	WA218
Aluminum T-Handle Lifter for 5 kg	WA446
Aluminum T-Handle Lifter for 2 kg	WA445
Aluminum T-Handle Lifter for 500 g — 1 kg	WA444
Aluminum Weight Lifter for 50 kg	WA456
Aluminum Weight Lifter for 20 kg	WA448
Aluminum Weight Lifter for 10 kg	WA447

Forceps

Forceps are designed for proper handling of weights. Stainless steel forceps are available in 5" and 8" sizes and are designed in a smooth tip, curved tip, straight grip tip, and a 22° grip tip. Stainless steel forceps tips are made of PVC. Troemner also offers economical polycarbonate forceps for weights 1 mg through 200 g.

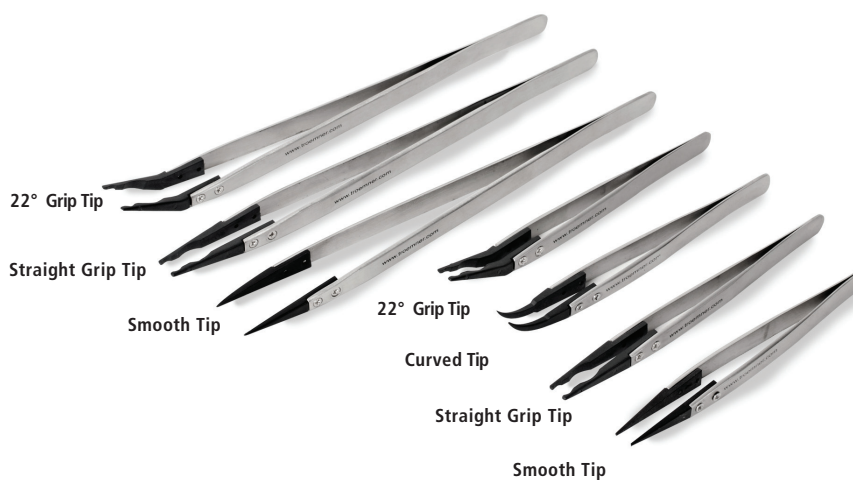

Analytical Precision Weights



OIML Precision Weights

Accessory

Clear Polycarbonate Forceps 4" (102 mm) (1 mg — 200 g)

Stainless Steel Forceps 8" (203 mm) 22° Grip Tip (1 g — 200 g)

Stainless Steel Forceps 8" (203 mm) Straight Grip Tip (1 g — 200 g)

Stainless Steel Forceps 8" (203 mm) Smooth Tip (1 mg — 20 g)

Stainless Steel Forceps 5" (127 mm) 22° Grip Tip (1 g — 200 g)

Stainless Steel Forceps 5" (127 mm) Curved Tip (1 mg — 500 mg)

Stainless Steel Forceps 5" (127 mm) Straight Grip Tip (1 g — 200 g)

Stainless Steel Forceps 5" (127 mm) Smooth Tip (1 mg — 500 mg)

Part

WA056

WA212

WA228

WA229

WA160

WA223

WA220

WA208

Weight Serialization

Etching or Stamping your weight(s) provides traceability of your weights as they move throughout your facility. Weights can be etched or stamped with a serial number or ID number that matches those on your Weight Calibration Certificate. For a list of weights that can be laser etched, please visit www.troemner.com or contact a Troemner Sales Representative at 800-249-5554 or troemner@troemner.com.



Laser Etching Serialization



Stamp Serialization

										Any Weight Style (excluding Cast Iron Weights)
Accessory										Part #
Laser Etching Serialization of Weights										691001—00
										Any Weight Style
Accessory										Part #
Stamp Serialization of Weights										691000—00

CALIBRATION+ SERVICES -

Troemner, LLC

201 Wolf Drive • Thorofare, NJ 08086
800.249.5554 • troemner@troemner.com
troemner.com

684032-00 (Rev 2 - 10/16)